

M23 Signal Connectors



Approvals

Tested acc. to DIN EN 61984

Features

Metallic types

- Variable cable clamp (Ø 5.5 – 12 mm)
- Special variable cable clamp up to 14.5 mm
- M 20 x 1.5 (PG 13,5) threaded back nut option – which offers 2nd cable clamp fixing for trailing cable applications
- Angled plug available

Plastic types

- Fixed cable clamp versions on demand and variable cable clamp (Ø 5.5 – 12 mm)

Advantages

- Pins or sockets can be used in every type depending on low power application 125V
- Machined Hypertac and stamped/rolled **HCS™** contacts can be used
- Stamped/rolled hyperboloid **HCS™** contacts are on reels for crimping machines and hand crimping tools with feeder line
- UL certification available. Contact the factory for relevant part numbers

Markets

Robots, machine tools, production machinery, encoders, servo drives, low voltage applications.

Technical Characteristics

Number of ways:	6way, 7way, 9way, 12way, 16way, 17way
Contact diameter:	6way, 7way, 9way, 12way, 16way, 17way 6way (6 x 2mm) 7way (7 x 2mm) 9way (8 x 1mm + 1 x 2mm); (6 x 1mm + 3 x 2mm); (9 x 1mm) 12way (12 x 1mm) 16way (16 x 1mm) 17way (17 x 1mm)
Nominal current (VDE) / 20°C:	Ø 1 mm 9 A Ø 2 mm 20 A
Contact resistance:	Ø 1 mm <3 mΩ Ø 2 mm <1,3 mΩ
Connector life cycle	500 mating cycles
Rated impulse voltage	Ø 1 mm 2,5 kV Ø 2 mm 2,5 kV
Max. operating voltage (Vrms):	Ø 1 mm 125 Ø 2 mm 125
Operating temperature range:	-40 °C to +125°C
Storage conditions	-40°C to +70°C / humidity 40%
Insulation resistance	Ø 1 mm 10 ¹² Ωcm Ø 2 mm 10 ¹⁶ Ωcm
Insulator material	PA, PBT, PPS
Contacts: a) material; b) plating	a) CuZn alloy, tin-bronze b) gold plated and partly gold plated
Shell: a) material, b) plating	a) plastic, CuZn alloy; zinc diecast b) nickel plated, chromium-plated
Seals:	FKM, NBR
IP code:	IP 67 mated
Contamination level:	3
Over voltage category:	III
Installation altitude:	up to 2000 m

Connector type overview

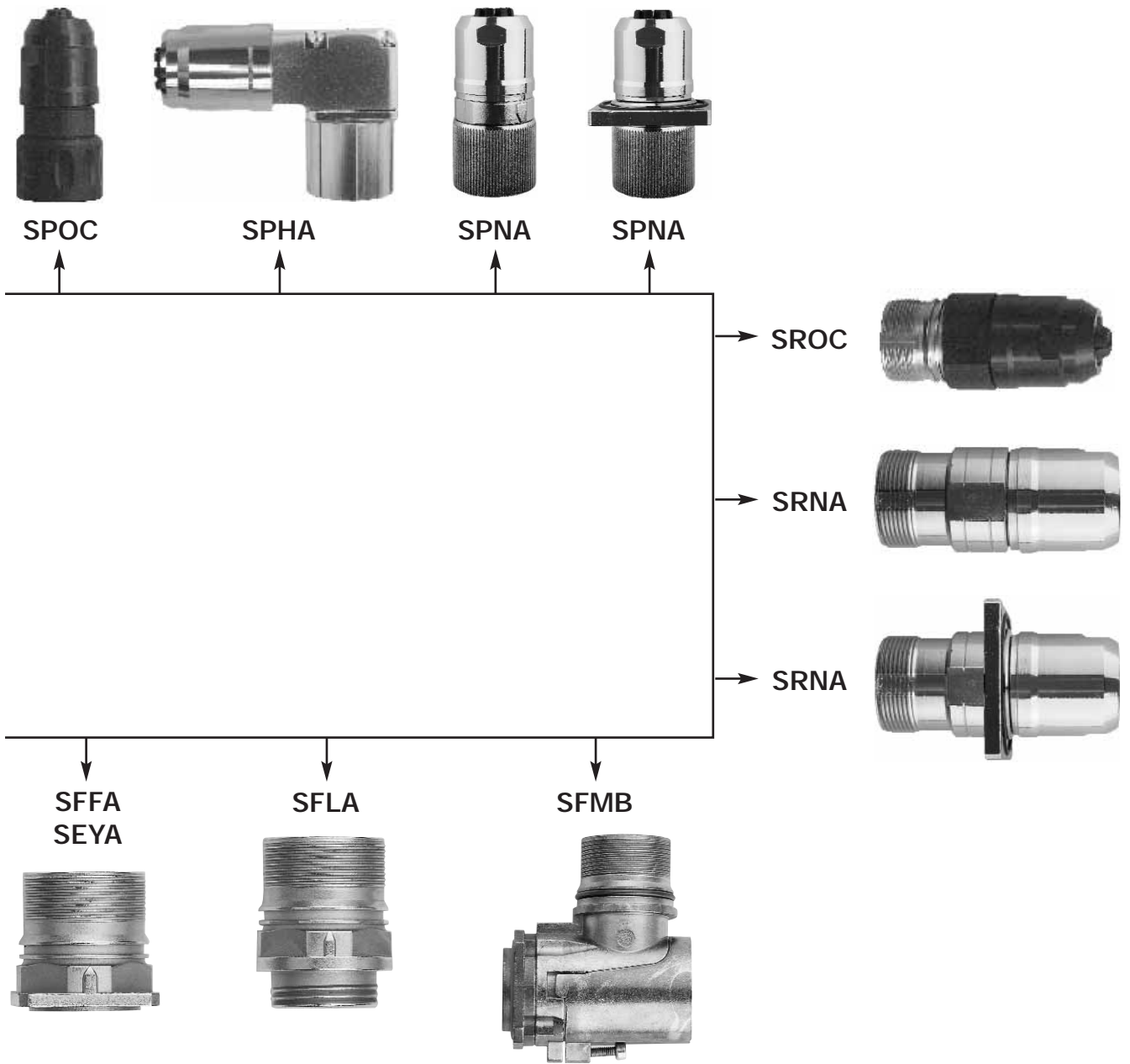

Connector dimensions

Standard types

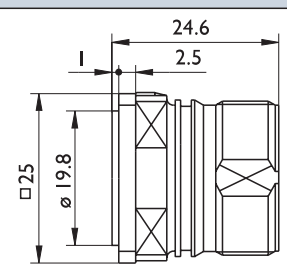
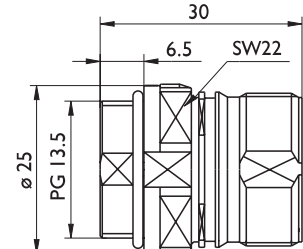
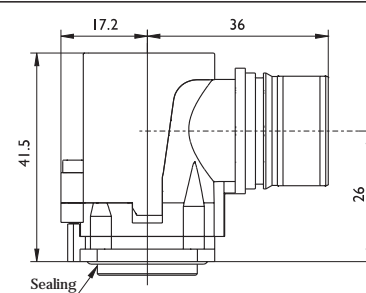
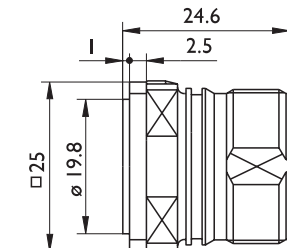
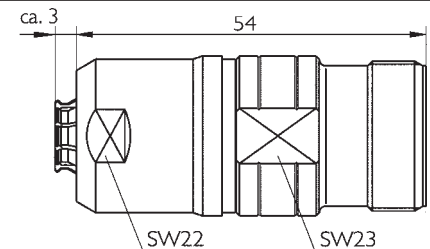
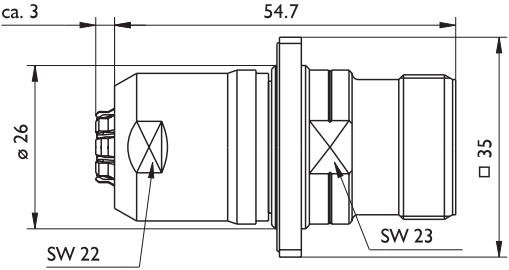
TYPE	DESCRIPTION	DRAWING
SFFA	Straight receptacle with axial sealing to the device, mounting holes for flange 2.7 mm	
SFLA	Straight receptacle with threaded connection	
SFMB	Rotateable angled receptacle with axial sealing to the device, mounting holes for flange 2.7 mm	
SEYA	Straight receptacle with axial sealing to the device, mounting holes for flange 3.2 mm	
SRNA	Extension with variable shield connection and cable clamp from Ø 5.5 to 12 mm	
SRNA with flange	Extension with mounting flange with variable shield connection and cable clamp from Ø 5.5 to 12 mm	

Dimensions are in mm

Connector dimensions

Standard types

TYPE	DESCRIPTION	DRAWING
SROC	Extension, plastic shell, with variable shield connection and variable cable clamp from Ø 5.5 to 12 mm	
SPNA	Plug with variable shield connection and cable clamp from Ø 5.5 to 12 mm	
SPNA with flange	Plug with flange, variable shield connection and cable clamp from Ø 5.5 to 12 mm	
SPOC	Plug, plastic shell, variable shield connection, variable cable clamp Ø 5.5 to 12 mm	
SPHA	Angled plug with variable shield connection and cable clamp from Ø 7.7 to 14.5 mm	

Dimensions are in mm

Ordering information guide

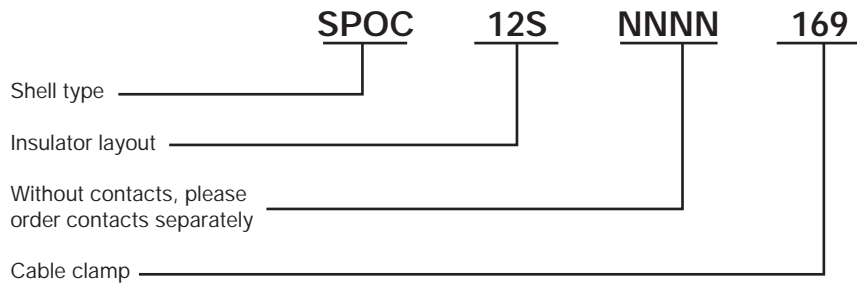

Ordering Information

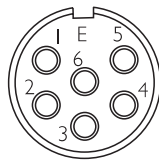
Receptacle 6way
(6 x 2mm)

Insulator seen from wired side
06G

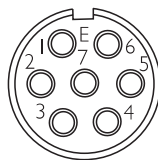
Connectors including insulator	Part numbers
Straight receptacle with axial sealing to the device, mounting holes for flange 2.7 mm	SFFA06GNNNN000
Straight receptacle with threaded connection PG 13,5	SFLA06GNNNN000
Rotateable angled receptacle with axial sealing to the device, mounting holes for flange 2.7 mm	SFMB06GNNNN000
Straight receptacle with axial sealing to the device, mounting holes for flange 3.2 mm	SEYA06GNNNN000
Contacts <i>please order separately</i>	Part numbers
Crimp pin Ø 2mm, 0,75 – 2,5 mm ² , AWG 18-14	021.310.1020
Crimp socket Ø 2mm, 0,5 – 1,5 mm ² , AWG 20-16	020.315.1020
Tools <i>please order separately</i>	Part numbers
Crimp tool Ø 2 mm	B-151
Positioner Ø 2 mm	B-201

Receptacle 7way
(7 x 2mm)

Insulator seen from wired side
07C

Connectors including insulator	Part numbers
Straight receptacle with axial sealing to the device, mounting holes for flange 2.7 mm	SFFA07CNNNN000
Straight receptacle with threaded connection PG 13,5	SFLA07CNNNN000
Rotateable angled receptacle with axial sealing to the device, mounting holes for flange 2.7 mm	SFMB07CNNNN000
Straight receptacle with axial sealing to the device, mounting holes for flange 3.2 mm	SEYA07CNNNN000
Contacts <i>please order separately</i>	Part numbers
Crimp pin Ø 2mm, 0,75 – 2,5 mm ² , AWG 18-14	021.310.1020
Crimp socket Ø 2mm, 0,5 – 1,5 mm ² , AWG 20-16	020.315.1020
Tools <i>please order separately</i>	Part numbers
Crimp tool Ø 2 mm	B-151
Positioner Ø 2 mm	B-201

Ordering Information

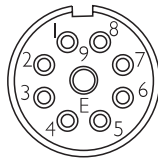
Receptacle 9way (8 x 1mm + 1 x 2mm)



Insulator seen from wired side

09E

Connectors including insulator	Part numbers
Straight receptacle with axial sealing to the device, mounting holes for flange 2.7 mm	SFFA09ENNNN000
Straight receptacle with threaded connection PG 13,5	SFLA09ENNNN000
Rotateable angled receptacle with axial sealing to the device, mounting holes for flange 2.7 mm	SFMB09ENNNN000
Straight receptacle with axial sealing to the device, mounting holes for flange 3.2 mm	SEYA09ENNNN000
Contacts <i>please order separately</i>	Part numbers
Crimp pin Ø 1mm, 0,24 – 1,0 mm ² , AWG 24-18	021.311.1020
Crimp pin Ø 2mm, 0,75 – 2,5 mm ² , AWG 18-14	021.310.1020
Crimp socket Ø 1mm, 0,24 – 1,0 mm ² , AWG 24-18	020.256.1020
Crimp socket Ø 2mm, 0,5 – 1,5 mm ² , AWG 20-16	020.315.1020
Tools <i>please order separately</i>	Part numbers
Crimp tool Ø 2mm	B-151
Crimp tool Ø 1mm	B-150
Positioner Ø 2mm	B-201
Positioner Ø 1mm	B-055/A

Receptacle 9way (6 x 1mm + 3 x 2mm)

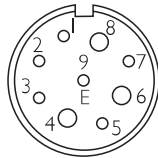

Insulator seen from wired side

09G

Connectors including insulator	Part numbers
Straight receptacle with axial sealing to the device, mounting holes for flange 2.7 mm	SFFA09GNNNN000
Straight receptacle with threaded connection PG 13,5	SFLA09GNNNN000
Rotateable angled receptacle with axial sealing to the device, mounting holes for flange 2.7 mm	SFMB09GNNNN000
Straight receptacle with axial sealing to the device, mounting holes for flange 3.2 mm	SEYA09GNNNN000
Contacts <i>please order separately</i>	Part numbers
Crimp pin Ø 1mm, 0,24 – 1,0 mm ² , AWG 24-18	021.311.1020
Crimp pin Ø 2mm, 0,75 – 2,5 mm ² , AWG 18-14	021.310.1020
Crimp socket Ø 1mm, 0,24 – 1,0 mm ² , AWG 24-18	020.256.1020
Crimp socket Ø 2mm, 0,5 – 1,5 mm ² , AWG 20-16	020.315.1020
Tools <i>please order separately</i>	Part numbers
Crimp tool Ø 2mm	B-151
Crimp tool Ø 1mm	B-150
Positioner Ø 2mm	B-201
Positioner Ø 1mm	B-055/A

Ordering Information

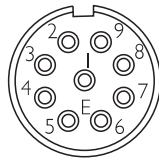
Receptacle 9 way
(9 x 1mm)

Insulator seen from wired side

09J

Connectors including insulator	Part numbers
Straight receptacle with axial sealing to the device, mounting holes for flange 2.7 mm	SFFA09JNNNN000
Straight receptacle with threaded connection PG 13,5	SFLA09JNNNN000
Rotateable angled receptacle with axial sealing to the device, mounting holes for flange 2.7 mm	SFMB09JNNNN000
Straight receptacle with axial sealing to the device, mounting holes for flange 3.2 mm	SEYA09JNNNN000
Contacts <i>please order separately</i>	Part numbers
Crimp pin Ø 1mm, 0,24 – 1,0 mm ² , AWG 24-18	021.311.1020
Crimp pin Ø 1mm, 0,05 – 0,34 mm ² , AWG 30 - 22	021.402.1020
Stamped/rolled pin Ø 1mm, 0,03 – 0,08 mm ² , AWG 32-28 HCS™	021.001005.1025 (9000 pcs./reel)
Stamped/rolled pin Ø 1mm, 0,03 – 0,08 mm ² , AWG 32-28 HCS™	021.001005.1025.A2 (300 pcs./reel)
Stamped/rolled pin Ø 1mm, 0,08 – 0,2 mm ² , AWG 28-24 HCS™	021.001006.1025 (9000 pcs./reel)
Stamped/rolled pin Ø 1mm, 0,08 – 0,2 mm ² , AWG 28-24 HCS™	021.001006.1025.A2 (300 pcs./reel)
Stamped/rolled pin Ø 1mm, 0,2 – 0,5 mm ² , AWG 24-20 HCS™	021.001007.1025 (9000 pcs./reel)
Stamped/rolled pin Ø 1mm, 0,2 – 0,5 mm ² , AWG 24-20 HCS™	021.001007.1025.A2 (300 pcs./reel)
Stamped/rolled pin Ø 1mm, 0,75 – 1,0 mm ² , AWG 18 HCS™	021.001008.1025 (9000 pcs./reel)
Stamped/rolled pin Ø 1mm, 0,75 – 1,0 mm ² , AWG 18 HCS™	021.001008.1025.A2 (300 pcs./reel)
Crimp socket Ø 1mm, 0,24 – 1,0 mm ² , AWG 24-18	020.256.1020
Crimp socket Ø 1mm, 0,05 – 0,34 mm ² , AWG 30 - 22	020.353.1020
Stamped/rolled socket Ø 1mm, 0,03 – 0,08 mm ² , AWG 32-28 HCS™	020.000376.2000 (9000 pcs./reel)
Stamped/rolled socket Ø 1mm, 0,03 – 0,08 mm ² , AWG 32-28 HCS™	020.000376.2000.A2 (300 pcs./reel)
Stamped/rolled socket Ø 1mm, 0,08 – 0,2 mm ² , AWG 28-24 HCS™	020.000377.2000 (9000 pcs./reel)
Stamped/rolled socket Ø 1mm, 0,08 – 0,2 mm ² , AWG 28-24 HCS™	020.000377.2000.A2 (300 pcs./reel)
Stamped/rolled socket Ø 1mm, 0,2 – 0,5 mm ² , AWG 24-20 HCS™	020.000378.2000 (9000 pcs./reel)
Stamped/rolled socket Ø 1mm, 0,2 – 0,5 mm ² , AWG 24-20 HCS™	020.000378.2000.A2 (300 pcs./reel)
Stamped/rolled socket Ø 1mm, 0,75 – 1,0 mm ² , AWG 18 HCS™	020.000379.2000 (9000 pcs./reel)
Stamped/rolled socket Ø 1mm, 0,75 – 1,0 mm ² , AWG 18 HCS™	020.000379.2000.A2 (300 pcs./reel)
Tools <i>please order separately</i>	Part numbers
Crimp tool Ø 1mm	B-150
Positioner Ø 1mm	B-055/A
Tools for stamped/rolled contacts <i>please order separately</i>	Part numbers
Hand crimping tool AWG 32-28	B-287/32-28
Applicator for crimping tool (Schäfer) AWG 32-28	B-288/32-28
Applicator for crimping tool (Kirsten PP3) AWG 32-28	B-286/32-28
Hand crimping tool AWG 28-24	B-287/28-24
Applicator for crimping tool (Schäfer) AWG 28-24	B-288/28-24
Applicator for crimping tool (Kirsten PP3) AWG 28-24	B-286/28-24
Hand crimping tool AWG 24-20	B-287/24-20
Applicator for crimping tool (Schäfer) AWG 24-20	B-288/24-20
Applicator for crimping tool (Kirsten PP3) AWG 24-20	B-286/24-20
Hand crimping tool 0,75 – 1 mm ²	B-287/0,75-1
Applicator for crimping tool (Schäfer) 0,75 – 1 mm ²	B-288/0,75-1
Applicator for crimping tool (Kirsten PP3) 0,75 – 1 mm ²	B-286/0,75-1

Ordering Information

Receptacle 12way (12 x 1mm)

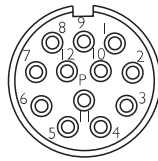

Insulator seen from wired side

12T

Connectors including insulator	Part numbers
Straight receptacle with axial sealing to the device, mounting holes for flange 2.7 mm	SFFA12TNNNN000
Straight receptacle with threaded connection PG 13,5	SFLA12TNNNN000
Rotatable angled receptacle with axial sealing to the device, mounting holes for flange 2.7 mm	SFMB12TNNNN000
Straight receptacle with axial sealing to the device, mounting holes for flange 3.2 mm	SEYA12TNNNN000
Contacts <i>please order separately</i>	Part numbers
Crimp pin Ø 1mm, 0,24 – 1,0 mm ² , AWG 24-18	021.311.1020
Crimp pin Ø 1mm, 0,05 – 0,34 mm ² , AWG 30 - 22	021.402.1020
Stamped/rolled pin Ø 1mm, 0,03 – 0,08 mm ² , AWG 32-28 HCS™	021.001005.1025 (9000 pcs./reel)
Stamped/rolled pin Ø 1mm, 0,03 – 0,08 mm ² , AWG 32-28 HCS™	021.001005.1025.A2 (300 pcs./reel)
Stamped/rolled pin Ø 1mm, 0,08 – 0,2 mm ² , AWG 28-24 HCS™	021.001006.1025 (9000 pcs./reel)
Stamped/rolled pin Ø 1mm, 0,08 – 0,2 mm ² , AWG 28-24 HCS™	021.001006.1025.A2 (300 pcs./reel)
Stamped/rolled pin Ø 1mm, 0,2 – 0,5 mm ² , AWG 24-20 HCS™	021.001007.1025 (9000 pcs./reel)
Stamped/rolled pin Ø 1mm, 0,2 – 0,5 mm ² , AWG 24-20 HCS™	021.001007.1025.A2 (300 pcs./reel)
Stamped/rolled pin Ø 1mm, 0,75 – 1,0 mm ² , AWG 18 HCS™	021.001008.1025 (9000 pcs./reel)
Stamped/rolled pin Ø 1mm, 0,75 – 1,0 mm ² , AWG 18 HCS™	021.001008.1025.A2 (300 pcs./reel)
Crimp socket Ø 1mm, 0,24 – 1,0 mm ² , AWG 24-18	020.256.1020
Crimp socket Ø 1mm, 0,05 – 0,34 mm ² , AWG 30 - 22	020.353.1020
Stamped/rolled socket Ø 1mm, 0,03 – 0,08 mm ² , AWG 32-28 HCS™	020.000376.2000 (9000 pcs./reel)
Stamped/rolled socket Ø 1mm, 0,03 – 0,08 mm ² , AWG 32-28 HCS™	020.000376.2000.A2 (300 pcs./reel)
Stamped/rolled socket Ø 1mm, 0,08 – 0,2 mm ² , AWG 28-24 HCS™	020.000377.2000 (9000 pcs./reel)
Stamped/rolled socket Ø 1mm, 0,08 – 0,2 mm ² , AWG 28-24 HCS™	020.000377.2000.A2 (300 pcs./reel)
Stamped/rolled socket Ø 1mm, 0,2 – 0,5 mm ² , AWG 24-20 HCS™	020.000378.2000 (9000 pcs./reel)
Stamped/rolled socket Ø 1mm, 0,2 – 0,5 mm ² , AWG 24-20 HCS™	020.000378.2000.A2 (300 pcs./reel)
Stamped/rolled socket Ø 1mm, 0,75 – 1,0 mm ² , AWG 18 HCS™	020.000379.2000 (9000 pcs./reel)
Stamped/rolled socket Ø 1mm, 0,75 – 1,0 mm ² , AWG 18 HCS™	020.000379.2000.A2 (300 pcs./reel)
Tools <i>please order separately</i>	Part numbers
Crimp tool Ø 1mm	B-150
Positioner Ø 1mm	B-055/A
Tools for stamped/rolled contacts <i>please order separately</i>	Part numbers
Hand crimping tool AWG 32-28	B-287/32-28
Applicator for crimping tool (Schäfer) AWG 32-28	B-288/32-28
Applicator for crimping tool (Kirsten PP3) AWG 32-28	B-286/32-28
Hand crimping tool AWG 28-24	B-287/28-24
Applicator for crimping tool (Schäfer) AWG 28-24	B-288/28-24
Applicator for crimping tool (Kirsten PP3) AWG 28-24	B-286/28-24
Hand crimping tool AWG 24-20	B-287/24-20
Applicator for crimping tool (Schäfer) AWG 24-20	B-288/24-20
Applicator for crimping tool (Kirsten PP3) AWG 24-20	B-286/24-20
Hand crimping tool 0,75 – 1 mm ²	B-287/0,75-1
Applicator for crimping tool (Schäfer) 0,75 – 1 mm ²	B-288/0,75-1
Applicator for crimping tool (Kirsten PP3) 0,75 – 1 mm ²	B-286/0,75-1

Ordering Information

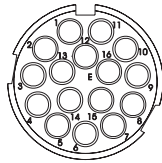
Receptacle 16way
(16 x 1mm)

Insulator seen from wired side

16A

Connectors including insulator	Part numbers
Straight receptacle with axial sealing to the device, mounting holes for flange 2.7 mm	SFFA16ANNNN000
Straight receptacle with threaded connection PG 13,5	SFLA16ANNNN000
Rotateable angled receptacle with axial sealing to the device, mounting holes for flange 2.7 mm	SFMB16ANNNN000
Straight receptacle with axial sealing to the device, mounting holes for flange 3.2 mm	SEYA16ANNNN000
Contacts <i>please order separately</i>	Part numbers
Crimp pin Ø 1mm, 0,24 – 1,0 mm ² , AWG 24-18	021.311.1020
Crimp pin Ø 1mm, 0,05 – 0,34 mm ² , AWG 30 - 22	021.402.1020
Stamped/rolled pin Ø 1mm, 0,03 – 0,08 mm ² , AWG 32-28 HCS™	021.001005.1025 (9000 pcs./reel)
Stamped/rolled pin Ø 1mm, 0,03 – 0,08 mm ² , AWG 32-28 HCS™	021.001005.1025.A2 (300 pcs./reel)
Stamped/rolled pin Ø 1mm, 0,08 – 0,2 mm ² , AWG 28-24 HCS™	021.001006.1025 (9000 pcs./reel)
Stamped/rolled pin Ø 1mm, 0,08 – 0,2 mm ² , AWG 28-24 HCS™	021.001006.1025.A2 (300 pcs./reel)
Stamped/rolled pin Ø 1mm, 0,2 – 0,5 mm ² , AWG 24-20 HCS™	021.001007.1025 (9000 pcs./reel)
Stamped/rolled pin Ø 1mm, 0,2 – 0,5 mm ² , AWG 24-20 HCS™	021.001007.1025.A2 (300 pcs./reel)
Stamped/rolled pin Ø 1mm, 0,75 – 1,0 mm ² , AWG 18 HCS™	021.001008.1025 (9000 pcs./reel)
Stamped/rolled pin Ø 1mm, 0,75 – 1,0 mm ² , AWG 18 HCS™	021.001008.1025.A2 (300 pcs./reel)
Crimp socket Ø 1mm, 0,24 – 1,0 mm ² , AWG 24-18	020.256.1020
Crimp socket Ø 1mm, 0,05 – 0,34 mm ² , AWG 30 - 22	020.353.1020
Stamped/rolled socket Ø 1mm, 0,03 – 0,08 mm ² , AWG 32-28 HCS™	020.000376.2000 (9000 pcs./reel)
Stamped/rolled socket Ø 1mm, 0,03 – 0,08 mm ² , AWG 32-28 HCS™	020.000376.2000.A2 (300 pcs./reel)
Stamped/rolled socket Ø 1mm, 0,08 – 0,2 mm ² , AWG 28-24 HCS™	020.000377.2000 (9000 pcs./reel)
Stamped/rolled socket Ø 1mm, 0,08 – 0,2 mm ² , AWG 28-24 HCS™	020.000377.2000.A2 (300 pcs./reel)
Stamped/rolled socket Ø 1mm, 0,2 – 0,5 mm ² , AWG 24-20 HCS™	020.000378.2000 (9000 pcs./reel)
Stamped/rolled socket Ø 1mm, 0,2 – 0,5 mm ² , AWG 24-20 HCS™	020.000378.2000.A2 (300 pcs./reel)
Stamped/rolled socket Ø 1mm, 0,75 – 1,0 mm ² , AWG 18 HCS™	020.000379.2000 (9000 pcs./reel)
Stamped/rolled socket Ø 1mm, 0,75 – 1,0 mm ² , AWG 18 HCS™	020.000379.2000.A2 (300 pcs./reel)
Tools <i>please order separately</i>	Part numbers
Crimp tool Ø 1mm	B-150
Positioner Ø 1mm	B-055/A
Tools for stamped/rolled contacts <i>please order separately</i>	Part numbers
Hand crimping tool AWG 32-28	B-287/32-28
Applicator for crimping tool (Schäfer) AWG 32-28	B-288/32-28
Applicator for crimping tool (Kirsten PP3) AWG 32-28	B-286/32-28
Hand crimping tool AWG 28-24	B-287/28-24
Applicator for crimping tool (Schäfer) AWG 28-24	B-288/28-24
Applicator for crimping tool (Kirsten PP3) AWG 28-24	B-286/28-24
Hand crimping tool AWG 24-20	B-287/24-20
Applicator for crimping tool (Schäfer) AWG 24-20	B-288/24-20
Applicator for crimping tool (Kirsten PP3) AWG 24-20	B-286/24-20
Hand crimping tool 0,75 – 1 mm ²	B-287/0,75-1
Applicator for crimping tool (Schäfer) 0,75 – 1 mm ²	B-288/0,75-1
Applicator for crimping tool (Kirsten PP3) 0,75 – 1 mm ²	B-286/0,75-1

Ordering Information

Receptacle 17way (17 x 1mm)

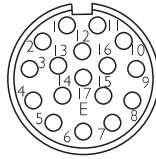

Insulator seen from wired side

17G

Connectors including insulator	Part numbers
Straight receptacle with axial sealing to the device, mounting holes for flange 2.7 mm	SFFA17GNNNN000
Straight receptacle with threaded connection PG 13,5	SFLA17GNNNN000
Rotatable angled receptacle with axial sealing to the device, mounting holes for flange 2.7 mm	SFMB17GNNNN000
Straight receptacle with axial sealing to the device, mounting holes for flange 3.2 mm	SEYA17GNNNN000
Contacts <i>please order separately</i>	Part numbers
Crimp pin Ø 1mm, 0,24 – 1,0 mm ² , AWG 24-18	021.311.1020
Crimp pin Ø 1mm, 0,05 – 0,34 mm ² , AWG 30 - 22	021.402.1020
Stamped/rolled pin Ø 1mm, 0,03 – 0,08 mm ² , AWG 32-28 HCS™	021.001005.1025 (9000 pcs./reel)
Stamped/rolled pin Ø 1mm, 0,03 – 0,08 mm ² , AWG 32-28 HCS™	021.001005.1025.A2 (300 pcs./reel)
Stamped/rolled pin Ø 1mm, 0,08 – 0,2 mm ² , AWG 28-24 HCS™	021.001006.1025 (9000 pcs./reel)
Stamped/rolled pin Ø 1mm, 0,08 – 0,2 mm ² , AWG 28-24 HCS™	021.001006.1025.A2 (300 pcs./reel)
Stamped/rolled pin Ø 1mm, 0,2 – 0,5 mm ² , AWG 24-20 HCS™	021.001007.1025 (9000 pcs./reel)
Stamped/rolled pin Ø 1mm, 0,2 – 0,5 mm ² , AWG 24-20 HCS™	021.001007.1025.A2 (300 pcs./reel)
Stamped/rolled pin Ø 1mm, 0,75 – 1,0 mm ² , AWG 18 HCS™	021.001008.1025 (9000 pcs./reel)
Stamped/rolled pin Ø 1mm, 0,75 – 1,0 mm ² , AWG 18 HCS™	021.001008.1025.A2 (300 pcs./reel)
Crimp socket Ø 1mm, 0,24 – 1,0 mm ² , AWG 24-18	020.256.1020
Crimp socket Ø 1mm, 0,05 – 0,34 mm ² , AWG 30 - 22	020.353.1020
Stamped/rolled socket Ø 1mm, 0,03 – 0,08 mm ² , AWG 32-28 HCS™	020.000376.2000 (9000 pcs./reel)
Stamped/rolled socket Ø 1mm, 0,03 – 0,08 mm ² , AWG 32-28 HCS™	020.000376.2000.A2 (300 pcs./reel)
Stamped/rolled socket Ø 1mm, 0,08 – 0,2 mm ² , AWG 28-24 HCS™	020.000377.2000 (9000 pcs./reel)
Stamped/rolled socket Ø 1mm, 0,08 – 0,2 mm ² , AWG 28-24 HCS™	020.000377.2000.A2 (300 pcs./reel)
Stamped/rolled socket Ø 1mm, 0,2 – 0,5 mm ² , AWG 24-20 HCS™	020.000378.2000 (9000 pcs./reel)
Stamped/rolled socket Ø 1mm, 0,2 – 0,5 mm ² , AWG 24-20 HCS™	020.000378.2000.A2 (300 pcs./reel)
Stamped/rolled socket Ø 1mm, 0,75 – 1,0 mm ² , AWG 18 HCS™	020.000379.2000 (9000 pcs./reel)
Stamped/rolled socket Ø 1mm, 0,75 – 1,0 mm ² , AWG 18 HCS™	020.000379.2000.A2 (300 pcs./reel)
Tools <i>please order separately</i>	Part numbers
Crimp tool Ø 1mm	B-150
Positioner Ø 1mm	B-055/A
Tools for stamped/rolled contacts <i>please order separately</i>	Part numbers
Hand crimping tool AWG 32-28	B-287/32-28
Applicator for crimping tool (Schäfer) AWG 32-28	B-288/32-28
Applicator for crimping tool (Kirsten PP3) AWG 32-28	B-286/32-28
Hand crimping tool AWG 28-24	B-287/28-24
Applicator for crimping tool (Schäfer) AWG 28-24	B-288/28-24
Applicator for crimping tool (Kirsten PP3) AWG 28-24	B-286/28-24
Hand crimping tool AWG 24-20	B-287/24-20
Applicator for crimping tool (Schäfer) AWG 24-20	B-288/24-20
Applicator for crimping tool (Kirsten PP3) AWG 24-20	B-286/24-20
Hand crimping tool 0,75 – 1 mm ²	B-287/0,75-1
Applicator for crimping tool (Schäfer) 0,75 – 1 mm ²	B-288/0,75-1
Applicator for crimping tool (Kirsten PP3) 0,75 – 1 mm ²	B-286/0,75-1

Ordering Information

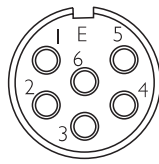
Extension 6way
(6 x 2 mm)

06G

Insulator seen from wired side

Connectors including insulator and cable clamp	Part numbers
Extension with variable shield connection and cable clamp from Ø 5.5 to 12 mm	SRNA06GNNNN169
Extension with mounting flange with variable shield connection and cable clamp from Ø 5.5 to 12 mm	SRNA06GNNNN16901
Extension, plastic shell, with variable shield connection and variable cable clamp from Ø 5.5 to 12 mm	SROC06GNNNN169
Contacts <i>please order separately</i>	Part numbers
Crimp pin Ø 2mm, 0,75 – 2,5 mm ² , AWG 18-14	021.310.1020
Crimp socket Ø 2mm, 0,5 – 1,5 mm ² , AWG 20-16	020.315.1020
Tools <i>please order separately</i>	Part numbers
Crimp tool Ø 2mm	B-151
Positioner Ø 2mm	B-201

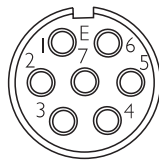
Extension 7way
(7 x 2 mm)

07C

Insulator seen from wired side

Connectors including insulator and cable clamp	Part numbers
Extension with variable shield connection and cable clamp from Ø 5.5 to 12 mm	SRNA07CNNNN169
Extension with mounting flange with variable shield connection and cable clamp from Ø 5.5 to 12 mm	SRNA07CNNNN16901
Extension, plastic shell, with variable shield connection and variable cable clamp from Ø 5.5 to 12 mm	SROC07CNNNN169
Contacts <i>please order separately</i>	Part numbers
Crimp pin Ø 2mm, 0,75 – 2,5 mm ² , AWG 18-14	021.310.1020
Crimp socket Ø 2mm, 0,5 – 1,5 mm ² , AWG 20-16	020.315.1020
Tools <i>please order separately</i>	Part numbers
Crimp tool Ø 2mm	B-151
Positioner Ø 2mm	B-201

Ordering Information

Extension 9way
(8 x 1mm + 1 x 2mm)

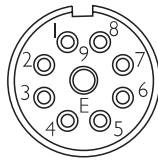

Insulator seen from wired side

09E

Connectors including insulator and cable clamp	Part numbers
Extension with variable shield connection and cable clamp from Ø 5.5 to 12 mm	SRNA09ENNNN169
Extension with mounting flange with variable shield connection and cable clamp from Ø 5.5 to 12 mm	SRNA09ENNNN16901
Extension, plastic shell, with variable shield connection and variable cable clamp from Ø 5.5 to 12 mm	SROC09ENNNN169
Contacts <i>please order separately</i>	Part numbers
Crimp pin Ø 1mm, 0,24 – 1,0 mm ² , AWG 24-18	021.311.1020
Crimp pin Ø 2mm, 0,75 – 2,5 mm ² , AWG 18-14	021.310.1020
Crimp socket Ø 1mm, 0,24 – 1,0 mm ² , AWG 24-18	020.256.1020
Crimp socket Ø 2mm, 0,5 – 1,5 mm ² , AWG 20-16	020.315.1020
Tools <i>please order separately</i>	Part numbers
Crimp tool Ø 2mm	B-151
Crimp tool Ø 1mm	B-150
Positioner Ø 2mm	B-201
Positioner Ø 1mm	B-055/A

Extension 9way
(6 x 1mm + 3 x 2mm)

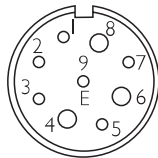

Insulator seen from wired side

09G

Connectors including insulator and cable clamp	Part numbers
Extension with variable shield connection and cable clamp from Ø 5.5 to 12 mm	SRNA09GNNNN169
Extension with mounting flange with variable shield connection and cable clamp from Ø 5.5 to 12 mm	SRNA09GNNNN16901
Extension, plastic shell, with variable shield connection and variable cable clamp from Ø 5.5 to 12 mm	SROC09GNNNN169
Contacts <i>please order separately</i>	Part numbers
Crimp pin Ø 1mm, 0,24 – 1,0 mm ² , AWG 24-18	021.311.1020
Crimp pin Ø 2mm, 0,75 – 2,5 mm ² , AWG 18-14	021.310.1020
Crimp socket Ø 1mm, 0,24 – 1,0 mm ² , AWG 24-18	020.256.1020
Crimp socket Ø 2mm, 0,5 – 1,5 mm ² , AWG 20-16	020.315.1020
Tools <i>please order separately</i>	Part numbers
Crimp tool Ø 2mm	B-151
Crimp tool Ø 1mm	B-150
Positioner Ø 2mm	B-201
Positioner Ø 1mm	B-055/A

Ordering Information

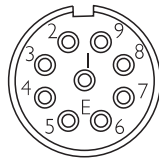
 Extension 9way
 (9 x 1mm)

Insulator seen from wired side

09J

Connectors including insulator and cable clamp	Part numbers
Extension with variable shield connection and cable clamp from Ø 5.5 to 12 mm	SRNA09JNNNN169
Extension with mounting flange with variable shield connection and cable clamp from Ø 5.5 to 12 mm	SRNA09JNNNN16901
Extension, plastic shell, with variable shield connection and variable cable clamp from Ø 5.5 to 12 mm	SROC09JNNNN169
Contacts <i>please order separately</i>	Part numbers
Crimp pin Ø 1mm, 0,24 – 1,0 mm ² , AWG 24-18	021.311.1020
Crimp pin Ø 1mm, 0,05 – 0,34 mm ² , AWG 30-22	021.402.1020
Stamped/rolled pin Ø 1mm, 0,03 – 0,08 mm ² , AWG 32-28 HCS™	021.001005.1025 (9000 pcs./reel)
Stamped/rolled pin Ø 1mm, 0,03 – 0,08 mm ² , AWG 32-28 HCS™	021.001005.1025.A2 (300 pcs./reel)
Stamped/rolled pin Ø 1mm, 0,08 – 0,2 mm ² , AWG 28-24 HCS™	021.001006.1025 (9000 pcs./reel)
Stamped/rolled pin Ø 1mm, 0,08 – 0,2 mm ² , AWG 28-24 HCS™	021.001006.1025.A2 (300 pcs./reel)
Stamped/rolled pin Ø 1mm, 0,2 – 0,5 mm ² , AWG 24-20 HCS™	021.001007.1025 (9000 pcs./reel)
Stamped/rolled pin Ø 1mm, 0,2 – 0,5 mm ² , AWG 24-20 HCS™	021.001007.1025.A2 (300 pcs./reel)
Stamped/rolled pin Ø 1mm, 0,75 – 1,0 mm ² , AWG 18 HCS™	021.001008.1025 (9000 pcs./reel)
Stamped/rolled pin Ø 1mm, 0,75 – 1,0 mm ² , AWG 18 HCS™	021.001008.1025.A2 (300 pcs./reel)
Crimp socket Ø 1mm, 0,24 – 1,0 mm ² , AWG 24-18	020.256.1020
Crimp socket Ø 1mm, 0,05 – 0,34 mm ² , AWG 30-22	020.353.1020
Stamped/rolled socket Ø 1mm, 0,03 – 0,08 mm ² , AWG 32-28 HCS™	020.000376.2000 (9000 pcs./reel)
Stamped/rolled socket Ø 1mm, 0,03 – 0,08 mm ² , AWG 32-28 HCS™	020.000376.2000.A2 (300 pcs./reel)
Stamped/rolled socket Ø 1mm, 0,08 – 0,2 mm ² , AWG 28-24 HCS™	020.000377.2000 (9000 pcs./reel)
Stamped/rolled socket Ø 1mm, 0,08 – 0,2 mm ² , AWG 28-24 HCS™	020.000377.2000.A2 (300 pcs./reel)
Stamped/rolled socket Ø 1mm, 0,2 – 0,5 mm ² , AWG 24-20 HCS™	020.000378.2000 (9000 pcs./reel)
Stamped/rolled socket Ø 1mm, 0,2 – 0,5 mm ² , AWG 24-20 HCS™	020.000378.2000.A2 (300 pcs./reel)
Stamped/rolled socket Ø 1mm, 0,75 – 1,0 mm ² , AWG 18 HCS™	020.000379.2000 (9000 pcs./reel)
Stamped/rolled socket Ø 1mm, 0,75 – 1,0 mm ² , AWG 18 HCS™	020.000379.2000.A2 (300 pcs./reel)
Tools <i>please order separately</i>	Part numbers
Crimp tool Ø 1mm	B-150
Positioner Ø 1mm	B-055/A
Tools for stamped/rolled contacts <i>please order separately</i>	Part numbers
Hand crimping tool AWG 32-28	B-287/32-28
Applicator for crimping tool (Schäfer) AWG 32-28	B-288/32-28
Applicator for crimping tool (Kirsten PP3) AWG 32-28	B-286/32-28
Hand crimping tool AWG 28-24	B-287/28-24
Applicator for crimping tool (Schäfer) AWG 28-24	B-288/28-24
Applicator for crimping tool (Kirsten PP3) AWG 28-24	B-286/28-24
Hand crimping tool AWG 24-20	B-287/24-20
Applicator for crimping tool (Schäfer) AWG 24-20	B-288/24-20
Applicator for crimping tool (Kirsten PP3) AWG 24-20	B-286/24-20
Hand crimping tool 0,75 – 1 mm ²	B-287/0,75-1
Applicator for crimping tool (Schäfer) 0,75 – 1 mm ²	B-288/0,75-1
Applicator for crimping tool (Kirsten PP3) 0,75 – 1 mm ²	B-286/0,75-1

Ordering Information

Extension 12way (12 x 1mm)

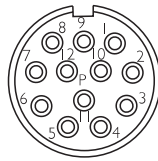

12T

Insulator seen from wired side

Connectors including insulator and cable clamp	Part numbers
Extension with variable shield connection and cable clamp from Ø 5.5 to 12 mm	SRNA12TNNNN169
Extension with mounting flange with variable shield connection and cable clamp from Ø 5.5 to 12 mm	SRNA12TNNNN16901
Extension, plastic shell, with variable shield connection and variable cable clamp from Ø 5.5 to 12 mm	SROC12TNNNN169
Contacts <i>please order separately</i>	Part numbers
Crimp pin Ø 1mm, 0,24 – 1,0 mm ² , AWG 24-18	021.311.1020
Crimp pin Ø 1mm, 0,05 – 0,34 mm ² , AWG 30-22	021.402.1020
Stamped/rolled pin Ø 1mm, 0,03 – 0,08 mm ² , AWG 32-28 HCS™	021.001005.1025 (9000 pcs./reel)
Stamped/rolled pin Ø 1mm, 0,03 – 0,08 mm ² , AWG 32-28 HCS™	021.001005.1025.A2 (300 pcs./reel)
Stamped/rolled pin Ø 1mm, 0,08 – 0,2 mm ² , AWG 28-24 HCS™	021.001006.1025 (9000 pcs./reel)
Stamped/rolled pin Ø 1mm, 0,08 – 0,2 mm ² , AWG 28-24 HCS™	021.001006.1025.A2 (300 pcs./reel)
Stamped/rolled pin Ø 1mm, 0,2 – 0,5 mm ² , AWG 24-20 HCS™	021.001007.1025 (9000 pcs./reel)
Stamped/rolled pin Ø 1mm, 0,2 – 0,5 mm ² , AWG 24-20 HCS™	021.001007.1025.A2 (300 pcs./reel)
Stamped/rolled pin Ø 1mm, 0,75 – 1,0 mm ² , AWG 18 HCS™	021.001008.1025 (9000 pcs./reel)
Stamped/rolled pin Ø 1mm, 0,75 – 1,0 mm ² , AWG 18 HCS™	021.001008.1025.A2 (300 pcs./reel)
Crimp socket Ø 1mm, 0,24 – 1,0 mm ² , AWG 24-18	020.256.1020
Crimp socket Ø 1mm, 0,05 – 0,34 mm ² , AWG 30-22	020.353.1020
Stamped/rolled socket Ø 1mm, 0,03 – 0,08 mm ² , AWG 32-28 HCS™	020.000376.2000 (9000 pcs./reel)
Stamped/rolled socket Ø 1mm, 0,03 – 0,08 mm ² , AWG 32-28 HCS™	020.000376.2000.A2 (300 pcs./reel)
Stamped/rolled socket Ø 1mm, 0,08 – 0,2 mm ² , AWG 28-24 HCS™	020.000377.2000 (9000 pcs./reel)
Stamped/rolled socket Ø 1mm, 0,08 – 0,2 mm ² , AWG 28-24 HCS™	020.000377.2000.A2 (300 pcs./reel)
Stamped/rolled socket Ø 1mm, 0,2 – 0,5 mm ² , AWG 24-20 HCS™	020.000378.2000 (9000 pcs./reel)
Stamped/rolled socket Ø 1mm, 0,2 – 0,5 mm ² , AWG 24-20 HCS™	020.000378.2000.A2 (300 pcs./reel)
Stamped/rolled socket Ø 1mm, 0,75 – 1,0 mm ² , AWG 18 HCS™	020.000379.2000 (9000 pcs./reel)
Stamped/rolled socket Ø 1mm, 0,75 – 1,0 mm ² , AWG 18 HCS™	020.000379.2000.A2 (300 pcs./reel)
Tools <i>please order separately</i>	Part numbers
Crimp tool Ø 1mm	B-150
Positioner Ø 1mm	B-055/A
Tools for stamped/rolled contacts <i>please order separately</i>	Part numbers
Hand crimping tool AWG 32-28	B-287/32-28
Applicator for crimping tool (Schäfer) AWG 32-28	B-288/32-28
Applicator for crimping tool (Kirsten PP3) AWG 32-28	B-286/32-28
Hand crimping tool AWG 28-24	B-287/28-24
Applicator for crimping tool (Schäfer) AWG 28-24	B-288/28-24
Applicator for crimping tool (Kirsten PP3) AWG 28-24	B-286/28-24
Hand crimping tool AWG 24-20	B-287/24-20
Applicator for crimping tool (Schäfer) AWG 24-20	B-288/24-20
Applicator for crimping tool (Kirsten PP3) AWG 24-20	B-286/24-20
Hand crimping tool 0,75 – 1 mm ²	B-287/0,75-1
Applicator for crimping tool (Schäfer) 0,75 – 1 mm ²	B-288/0,75-1
Applicator for crimping tool (Kirsten PP3) 0,75 – 1 mm ²	B-286/0,75-1

Ordering Information

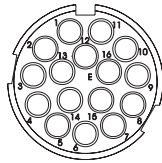
 Extension 16way
 (16 x 1mm)

Insulator seen from wired side

16A

Connectors including insulator and cable clamp	Part numbers
Extension with variable shield connection and cable clamp from Ø 5.5 to 12 mm	SRNA16ANNNN169
Extension with mounting flange with variable shield connection and cable clamp from Ø 5.5 to 12 mm	SRNA16ANNNN16901
Extension, plastic shell, with variable shield connection and variable cable clamp from Ø 5.5 to 12 mm	SROC16ANNNN169
Contacts <i>please order separately</i>	Part numbers
Crimp pin Ø 1mm, 0,24 – 1,0 mm ² , AWG 24-18	021.311.1020
Crimp pin Ø 1mm, 0,05 – 0,34 mm ² , AWG 30-22	021.402.1020
Stamped/rolled pin Ø 1mm, 0,03 – 0,08 mm ² , AWG 32-28 HCS™	021.001005.1025 (9000 pcs./reel)
Stamped/rolled pin Ø 1mm, 0,03 – 0,08 mm ² , AWG 32-28 HCS™	021.001005.1025.A2 (300 pcs./reel)
Stamped/rolled pin Ø 1mm, 0,08 – 0,2 mm ² , AWG 28-24 HCS™	021.001006.1025 (9000 pcs./reel)
Stamped/rolled pin Ø 1mm, 0,08 – 0,2 mm ² , AWG 28-24 HCS™	021.001006.1025.A2 (300 pcs./reel)
Stamped/rolled pin Ø 1mm, 0,2 – 0,5 mm ² , AWG 24-20 HCS™	021.001007.1025 (9000 pcs./reel)
Stamped/rolled pin Ø 1mm, 0,2 – 0,5 mm ² , AWG 24-20 HCS™	021.001007.1025.A2 (300 pcs./reel)
Stamped/rolled pin Ø 1mm, 0,75 – 1,0 mm ² , AWG 18 HCS™	021.001008.1025 (9000 pcs./reel)
Stamped/rolled pin Ø 1mm, 0,75 – 1,0 mm ² , AWG 18 HCS™	021.001008.1025.A2 (300 pcs./reel)
Crimp socket Ø 1mm, 0,24 – 1,0 mm ² , AWG 24-18	020.256.1020
Crimp socket Ø 1mm, 0,05 – 0,34 mm ² , AWG 30-22	020.353.1020
Stamped/rolled socket Ø 1mm, 0,03 – 0,08 mm ² , AWG 32-28 HCS™	020.000376.2000 (9000 pcs./reel)
Stamped/rolled socket Ø 1mm, 0,03 – 0,08 mm ² , AWG 32-28 HCS™	020.000376.2000.A2 (300 pcs./reel)
Stamped/rolled socket Ø 1mm, 0,08 – 0,2 mm ² , AWG 28-24 HCS™	020.000377.2000 (9000 pcs./reel)
Stamped/rolled socket Ø 1mm, 0,08 – 0,2 mm ² , AWG 28-24 HCS™	020.000377.2000.A2 (300 pcs./reel)
Stamped/rolled socket Ø 1mm, 0,2 – 0,5 mm ² , AWG 24-20 HCS™	020.000378.2000 (9000 pcs./reel)
Stamped/rolled socket Ø 1mm, 0,2 – 0,5 mm ² , AWG 24-20 HCS™	020.000378.2000.A2 (300 pcs./reel)
Stamped/rolled socket Ø 1mm, 0,75 – 1,0 mm ² , AWG 18 HCS™	020.000379.2000 (9000 pcs./reel)
Stamped/rolled socket Ø 1mm, 0,75 – 1,0 mm ² , AWG 18 HCS™	020.000379.2000.A2 (300 pcs./reel)
Tools <i>please order separately</i>	Part numbers
Crimp tool Ø 1mm	B-150
Positioner Ø 1mm	B-055/A
Tools for stamped/rolled contacts <i>please order separately</i>	Part numbers
Hand crimping tool AWG 32-28	B-287/32-28
Applicator for crimping tool (Schäfer) AWG 32-28	B-288/32-28
Applicator for crimping tool (Kirsten PP3) AWG 32-28	B-286/32-28
Hand crimping tool AWG 28-24	B-287/28-24
Applicator for crimping tool (Schäfer) AWG 28-24	B-288/28-24
Applicator for crimping tool (Kirsten PP3) AWG 28-24	B-286/28-24
Hand crimping tool AWG 24-20	B-287/24-20
Applicator for crimping tool (Schäfer) AWG 24-20	B-288/24-20
Applicator for crimping tool (Kirsten PP3) AWG 24-20	B-286/24-20
Hand crimping tool 0,75 – 1 mm ²	B-287/0,75-1
Applicator for crimping tool (Schäfer) 0,75 – 1 mm ²	B-288/0,75-1
Applicator for crimping tool (Kirsten PP3) 0,75 – 1 mm ²	B-286/0,75-1

Ordering Information

Extension 17way (17 x 1mm)

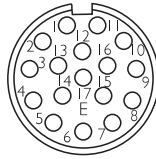

Insulator seen from wired side

17G

Connectors including insulator and cable clamp	Part numbers
Extension with variable shield connection and cable clamp from Ø 5.5 to 12 mm	SRNA17GNNNN169
Extension with mounting flange with variable shield connection and cable clamp from Ø 5.5 to 12 mm	SRNA17GNNNN16901
Extension, plastic shell, with variable shield connection and variable cable clamp from Ø 5.5 to 12 mm	SROC17GNNNN169
Contacts <i>please order separately</i>	Part numbers
Crimp pin Ø 1mm, 0,24 – 1,0 mm ² , AWG 24-18	021.311.1020
Crimp pin Ø 1mm, 0,05 – 0,34 mm ² , AWG 30-22	021.402.1020
Stamped/rolled pin Ø 1mm, 0,03 – 0,08 mm ² , AWG 32-28 HCS™	021.001005.1025 (9000 pcs./reel)
Stamped/rolled pin Ø 1mm, 0,03 – 0,08 mm ² , AWG 32-28 HCS™	021.001005.1025.A2 (300 pcs./reel)
Stamped/rolled pin Ø 1mm, 0,08 – 0,2 mm ² , AWG 28-24 HCS™	021.001006.1025 (9000 pcs./reel)
Stamped/rolled pin Ø 1mm, 0,08 – 0,2 mm ² , AWG 28-24 HCS™	021.001006.1025.A2 (300 pcs./reel)
Stamped/rolled pin Ø 1mm, 0,2 – 0,5 mm ² , AWG 24-20 HCS™	021.001007.1025 (9000 pcs./reel)
Stamped/rolled pin Ø 1mm, 0,2 – 0,5 mm ² , AWG 24-20 HCS™	021.001007.1025.A2 (300 pcs./reel)
Stamped/rolled pin Ø 1mm, 0,75 – 1,0 mm ² , AWG 18 HCS™	021.001008.1025 (9000 pcs./reel)
Stamped/rolled pin Ø 1mm, 0,75 – 1,0 mm ² , AWG 18 HCS™	021.001008.1025.A2 (300 pcs./reel)
Crimp socket Ø 1mm, 0,24 – 1,0 mm ² , AWG 24-18	020.256.1020
Crimp socket Ø 1mm, 0,05 – 0,34 mm ² , AWG 30-22	020.353.1020
Stamped/rolled socket Ø 1mm, 0,03 – 0,08 mm ² , AWG 32-28 HCS™	020.000376.2000 (9000 pcs./reel)
Stamped/rolled socket Ø 1mm, 0,03 – 0,08 mm ² , AWG 32-28 HCS™	020.000376.2000.A2 (300 pcs./reel)
Stamped/rolled socket Ø 1mm, 0,08 – 0,2 mm ² , AWG 28-24 HCS™	020.000377.2000 (9000 pcs./reel)
Stamped/rolled socket Ø 1mm, 0,08 – 0,2 mm ² , AWG 28-24 HCS™	020.000377.2000.A2 (300 pcs./reel)
Stamped/rolled socket Ø 1mm, 0,2 – 0,5 mm ² , AWG 24-20 HCS™	020.000378.2000 (9000 pcs./reel)
Stamped/rolled socket Ø 1mm, 0,2 – 0,5 mm ² , AWG 24-20 HCS™	020.000378.2000.A2 (300 pcs./reel)
Stamped/rolled socket Ø 1mm, 0,75 – 1,0 mm ² , AWG 18 HCS™	020.000379.2000 (9000 pcs./reel)
Stamped/rolled socket Ø 1mm, 0,75 – 1,0 mm ² , AWG 18 HCS™	020.000379.2000.A2 (300 pcs./reel)
Tools <i>please order separately</i>	Part numbers
Crimp tool Ø 1mm	B-150
Positioner Ø 1mm	B-055/A
Tools for stamped/rolled contacts <i>please order separately</i>	Part numbers
Hand crimping tool AWG 32-28	B-287/32-28
Applicator for crimping tool (Schäfer) AWG 32-28	B-288/32-28
Applicator for crimping tool (Kirsten PP3) AWG 32-28	B-286/32-28
Hand crimping tool AWG 28-24	B-287/28-24
Applicator for crimping tool (Schäfer) AWG 28-24	B-288/28-24
Applicator for crimping tool (Kirsten PP3) AWG 28-24	B-286/28-24
Hand crimping tool AWG 24-20	B-287/24-20
Applicator for crimping tool (Schäfer) AWG 24-20	B-288/24-20
Applicator for crimping tool (Kirsten PP3) AWG 24-20	B-286/24-20
Hand crimping tool 0,75 – 1 mm ²	B-287/0,75-1
Applicator for crimping tool (Schäfer) 0,75 – 1 mm ²	B-288/0,75-1
Applicator for crimping tool (Kirsten PP3) 0,75 – 1 mm ²	B-286/0,75-1

Ordering Information

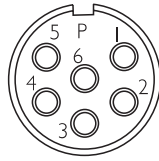
Plug 6way
 (6 x 2mm)

Insulator seen from wired side

06H

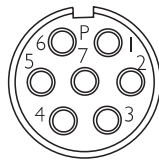
Connectors including insulator and cable clamp	Part numbers
Plug with variable shield connection and cable clamp form Ø 5.5 to 12 mm	SPNA06HNNNN169
Plug with flange, variable shield connection and cable clamp from Ø 5.5 to 12 mm	SPNA06HNNNN16914
Plug, plastic shell, variable shield connection, variable cable clamp from Ø 5.5 to 12 mm	SPOC06HNNNN169
Angled plug with variable shield connection and cable clamp from Ø 7.7 to 14.5 mm	SPHA06HNNNN17003
Contacts <i>please order separately</i>	Part numbers
Crimp pin Ø 2mm, 0,75 – 2,5 mm ² , AWG 18-14	021.310.1020
Crimp socket Ø 2mm, 0,05 – 1,5 mm ² , AWG 20-16	020.315.1020
Tools <i>please order separately</i>	Part numbers
Crimp tool Ø 2mm	B-151
Positioner Ø 2mm	B-201

Plug 7way
 (7 x 2mm)

Insulator seen from wired side

07D

Connectors including insulator and cable clamp	Part numbers
Plug with variable shield connection and cable clamp form Ø 5.5 to 12 mm	SPNA07DNNNN169
Plug with flange, variable shield connection and cable clamp from Ø 5.5 to 12 mm	SPNA07DNNNN16914
Plug, plastic shell, variable shield connection, variable cable clamp from Ø 5.5 to 12 mm	SPOC07DNNNN169
Angled plug with variable shield connection and cable clamp from Ø 7.7 to 14.5 mm	SPHA07DNNNN17003
Contacts <i>please order separately</i>	Part numbers
Crimp pin Ø 2mm, 0,75 – 2,5 mm ² , AWG 18-14	021.310.1020
Crimp socket Ø 2mm, 0,05 – 1,5 mm ² , AWG 20-16	020.315.1020
Tools <i>please order separately</i>	Part numbers
Crimp tool Ø 2mm	B-151
Positioner Ø 2mm	B-201

Ordering Information

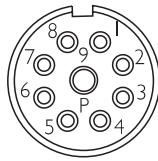
Plug 9way (8 x 1mm + 1 x 2mm)



Insulator seen from wired side

09F

Connectors including insulator and cable clamp	Part numbers
Plug with variable shield connection and cable clamp form Ø 5.5 to 12 mm	SPNA09FNNNN169
Plug with flange, variable shield connection and cable clamp from Ø 5.5 to 12 mm	SPNA09FNNNN16914
Plug, plastic shell, variable shield connection, variable cable clamp from Ø 5.5 to 12 mm	SPOC09FNNNN169
Angled plug with variable shield connection and cable clamp from Ø 7.7 to 14.5 mm	SPHA09FNNNN17003

Contacts <i>please order separately</i>	Part numbers
Crimp pin Ø 1mm, 0,24 – 1,0 mm ² , AWG 24-18	021.311.1020
Crimp pin Ø 2mm, 0,75 – 2,5 mm ² , AWG 18-14	021.310.1020
Crimp socket Ø 1mm, 0,24 – 1,0 mm ² , AWG 24-18	020.256.1020
Crimp socket Ø 2mm, 0,05 – 1,5 mm ² , AWG 20-16	020.315.1020

Tools <i>please order separately</i>	Part numbers
Crimp tool Ø 2mm	B-151
Crimp tool Ø 1mm	B-150
Positioner Ø 2mm	B-201
Positioner Ø 1mm	B-055/A

Plug 9way (6 x 1mm + 3 x 2mm)

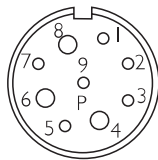

Insulator seen from wired side

09H

Connectors including insulator and cable clamp	Part numbers
Plug with variable shield connection and cable clamp form Ø 5.5 to 12 mm	SPNA09HNNNN169
Plug with flange, variable shield connection and cable clamp from Ø 5.5 to 12 mm	SPNA09HNNNN16914
Plug, plastic shell, variable shield connection, variable cable clamp from Ø 5.5 to 12 mm	SPOC09HNNNN169
Angled plug with variable shield connection and cable clamp from Ø 7.7 to 14.5 mm	SPHA09HNNNN17003

Contacts <i>please order separately</i>	Part numbers
Crimp pin Ø 1mm, 0,24 – 1,0 mm ² , AWG 24-18	021.311.1020
Crimp pin Ø 2mm, 0,75 – 2,5 mm ² , AWG 18-14	021.310.1020
Crimp socket Ø 1mm, 0,24 – 1,0 mm ² , AWG 24-18	020.256.1020
Crimp socket Ø 2mm, 0,5 – 1,5 mm ² , AWG 20-16	020.315.1020

Tools <i>please order separately</i>	Part numbers
Crimp tool Ø 2mm	B-151
Crimp tool Ø 1mm	B-150
Positioner Ø 2mm	B-201
Positioner Ø 1mm	B-055/A

Ordering Information

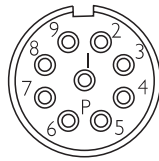
Plug 9way
(9 x 1mm)

Insulator seen from wired side

09K

Connectors including insulator and cable clamp	Part numbers
Plug with variable shield connection and cable clamp form Ø 5.5 to 12 mm	SPNA09KNNNN169
Plug with flange, variable shield connection and cable clamp from Ø 5.5 to 12 mm	SPNA09KNNNN16914
Plug, plastic shell, variable shield connection, variable cable clamp from Ø 5.5 to 12 mm	SPOC09KNNNN169
Angled plug with variable shield connection and cable clamp from Ø 7.7 to 14.5 mm	SPHA09KNNNN17003
Contacts <i>please order separately</i>	Part numbers
Crimp pin Ø 1mm, 0,24 – 1,0 mm ² , AWG 24-18	021.311.1020
Crimp pin Ø 1mm, 0,05 – 0,34 mm ² , AWG 30-22	021.402.1020
Stamped/rolled pin Ø 1mm, 0,03 – 0,08 mm ² , AWG 32-28 HCS™	021.001005.1025 (9000 pcs./reel)
Stamped/rolled pin Ø 1mm, 0,03 – 0,08 mm ² , AWG 32-28 HCS™	021.001005.1025.A2 (300 pcs./reel)
Stamped/rolled pin Ø 1mm, 0,08 – 0,2 mm ² , AWG 28-24 HCS™	021.001006.1025 (9000 pcs./reel)
Stamped/rolled pin Ø 1mm, 0,08 – 0,2 mm ² , AWG 28-24 HCS™	021.001006.1025.A2 (300 pcs./reel)
Stamped/rolled pin Ø 1mm, 0,2 – 0,5 mm ² , AWG 24-20 HCS™	021.001007.1025 (9000 pcs./reel)
Stamped/rolled pin Ø 1mm, 0,2 – 0,5 mm ² , AWG 24-20 HCS™	021.001007.1025.A2 (300 pcs./reel)
Stamped/rolled pin Ø 1mm, 0,75 – 1,0 mm ² , AWG 18 HCS™	021.001008.1025 (9000 pcs./reel)
Stamped/rolled pin Ø 1mm, 0,75 – 1,0 mm ² , AWG 18 HCS™	021.001008.1025.A2 (300 pcs./reel)
Crimp socket Ø 1mm, 0,24 – 1,0 mm ² , AWG 24-18	020.256.1020
Crimp socket Ø 1mm, 0,05 – 0,34 mm ² , AWG 30-22	020.353.1020
Stamped/rolled socket Ø 1mm, 0,03 – 0,08 mm ² , AWG 32-28 HCS™	020.000376.2000 (9000 pcs./reel)
Stamped/rolled socket Ø 1mm, 0,03 – 0,08 mm ² , AWG 32-28 HCS™	020.000376.2000.A2 (300 pcs./reel)
Stamped/rolled socket Ø 1mm, 0,08 – 0,2 mm ² , AWG 28-24 HCS™	020.000377.2000 (9000 pcs./reel)
Stamped/rolled socket Ø 1mm, 0,08 – 0,2 mm ² , AWG 28-24 HCS™	020.000377.2000.A2 (300 pcs./reel)
Stamped/rolled socket Ø 1mm, 0,2 – 0,5 mm ² , AWG 24-20 HCS™	020.000378.2000 (9000 pcs./reel)
Stamped/rolled socket Ø 1mm, 0,2 – 0,5 mm ² , AWG 24-20 HCS™	020.000378.2000.A2 (300 pcs./reel)
Stamped/rolled socket Ø 1mm, 0,75 – 1,0 mm ² , AWG 18 HCS™	020.000379.2000 (9000 pcs./reel)
Stamped/rolled socket Ø 1mm, 0,75 – 1,0 mm ² , AWG 18 HCS™	020.000379.2000.A2 (300 pcs./reel)
Tools <i>please order separately</i>	Part numbers
Crimp tool Ø 1mm	B-150
Positioner Ø 1mm	B-055/A
Tools for stamped/rolled contacts <i>please order separately</i>	Part numbers
Hand crimping tool AWG 32-28	B-287/32-28
Applicator for crimping tool (Schäfer) AWG 32-28	B-288/32-28
Applicator for crimping tool (Kirsten PP3) AWG 32-28	B-286/32-28
Hand crimping tool AWG 28-24	B-287/28-24
Applicator for crimping tool (Schäfer) AWG 28-24	B-288/28-24
Applicator for crimping tool (Kirsten PP3) AWG 28-24	B-286/28-24
Hand crimping tool AWG 24-20	B-287/24-20
Applicator for crimping tool (Schäfer) AWG 24-20	B-288/24-20
Applicator for crimping tool (Kirsten PP3) AWG 24-20	B-286/24-20
Hand crimping tool 0,75 – 1 mm ²	B-287/0,75-1
Applicator for crimping tool (Schäfer) 0,75 – 1 mm ²	B-288/0,75-1
Applicator for crimping tool (Kirsten PP3) 0,75 – 1 mm ²	B-286/0,75-1

Ordering Information

Plug 12way (12 x 1mm)

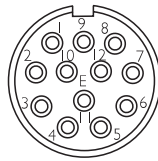

Insulator seen from wired side

12S

Connectors including insulator and cable clamp	Part numbers
Plug with variable shield connection and cable clamp form Ø 5.5 to 12 mm	SPNA12SNNNN169
Plug with flange, variable shield connection and cable clamp from Ø 5.5 to 12 mm	SPNA12SNNNN16914
Plug, plastic shell, variable shield connection, variable cable clamp from Ø 5.5 to 12 mm	SPOC12SNNNN169
Angled plug with variable shield connection and cable clamp from Ø 7.7 to 14.5 mm	SPHA12SNNNN17003
Contacts <i>please order separately</i>	Part numbers
Crimp pin Ø 1mm, 0,24 – 1,0 mm ² , AWG 24-18	021.311.1020
Crimp pin Ø 1mm, 0,05 – 0,34 mm ² , AWG 30-22	021.402.1020
Stamped/rolled pin Ø 1mm, 0,03 – 0,08 mm ² , AWG 32-28 HCS™	021.001005.1025 (9000 pcs./reel)
Stamped/rolled pin Ø 1mm, 0,03 – 0,08 mm ² , AWG 32-28 HCS™	021.001005.1025.A2 (300 pcs./reel)
Stamped/rolled pin Ø 1mm, 0,08 – 0,2 mm ² , AWG 28-24 HCS™	021.001006.1025 (9000 pcs./reel)
Stamped/rolled pin Ø 1mm, 0,08 – 0,2 mm ² , AWG 28-24 HCS™	021.001006.1025.A2 (300 pcs./reel)
Stamped/rolled pin Ø 1mm, 0,2 – 0,5 mm ² , AWG 24-20 HCS™	021.001007.1025 (9000 pcs./reel)
Stamped/rolled pin Ø 1mm, 0,2 – 0,5 mm ² , AWG 24-20 HCS™	021.001007.1025.A2 (300 pcs./reel)
Stamped/rolled pin Ø 1mm, 0,75 – 1,0 mm ² , AWG 18 HCS™	021.001008.1025 (9000 pcs./reel)
Stamped/rolled pin Ø 1mm, 0,75 – 1,0 mm ² , AWG 18 HCS™	021.001008.1025.A2 (300 pcs./reel)
Crimp socket Ø 1mm, 0,24 – 1,0 mm ² , AWG 24-18	020.256.1020
Crimp socket Ø 1mm, 0,05 – 0,34 mm ² , AWG 30-22	020.353.1020
Stamped/rolled socket Ø 1mm, 0,03 – 0,08 mm ² , AWG 32-28 HCS™	020.000376.2000 (9000 pcs./reel)
Stamped/rolled socket Ø 1mm, 0,03 – 0,08 mm ² , AWG 32-28 HCS™	020.000376.2000.A2 (300 pcs./reel)
Stamped/rolled socket Ø 1mm, 0,08 – 0,2 mm ² , AWG 28-24 HCS™	020.000377.2000 (9000 pcs./reel)
Stamped/rolled socket Ø 1mm, 0,08 – 0,2 mm ² , AWG 28-24 HCS™	020.000377.2000.A2 (300 pcs./reel)
Stamped/rolled socket Ø 1mm, 0,2 – 0,5 mm ² , AWG 24-20 HCS™	020.000378.2000 (9000 pcs./reel)
Stamped/rolled socket Ø 1mm, 0,2 – 0,5 mm ² , AWG 24-20 HCS™	020.000378.2000.A2 (300 pcs./reel)
Stamped/rolled socket Ø 1mm, 0,75 – 1,0 mm ² , AWG 18 HCS™	020.000379.2000 (9000 pcs./reel)
Stamped/rolled socket Ø 1mm, 0,75 – 1,0 mm ² , AWG 18 HCS™	020.000379.2000.A2 (300 pcs./reel)
Tools <i>please order separately</i>	Part numbers
Crimp tool Ø 1mm	B-150
Positioner Ø 1mm	B-055/A
Tools for stamped/rolled contacts <i>please order separately</i>	Part numbers
Hand crimping tool AWG 32-28	B-287/32-28
Applicator for crimping tool (Schäfer) AWG 32-28	B-288/32-28
Applicator for crimping tool (Kirsten PP3) AWG 32-28	B-286/32-28
Hand crimping tool AWG 28-24	B-287/28-24
Applicator for crimping tool (Schäfer) AWG 28-24	B-288/28-24
Applicator for crimping tool (Kirsten PP3) AWG 28-24	B-286/28-24
Hand crimping tool AWG 24-20	B-287/24-20
Applicator for crimping tool (Schäfer) AWG 24-20	B-288/24-20
Applicator for crimping tool (Kirsten PP3) AWG 24-20	B-286/24-20
Hand crimping tool 0,75 – 1 mm ²	B-287/0,75-1
Applicator for crimping tool (Schäfer) 0,75 – 1 mm ²	B-288/0,75-1
Applicator for crimping tool (Kirsten PP3) 0,75 – 1 mm ²	B-286/0,75-1

Ordering Information

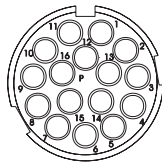
 Plug 16way
 (16 x 1mm)

Insulator seen from wired side

16B

Connectors including insulator and cable clamp	Part numbers
Plug with variable shield connection and cable clamp form Ø 5.5 to 12 mm	SPNA16BNNNN169
Plug with flange, variable shield connection and cable clamp from Ø 5.5 to 12 mm	SPNA16BNNNN16914
Plug, plastic shell, variable shield connection, variable cable clamp from Ø 5.5 to 12 mm	SPOC16BNNNN169
Angled plug with variable shield connection and cable clamp from Ø 7.7 to 14.5 mm	SPHA16BNNNN17003
Contacts <i>please order separately</i>	Part numbers
Crimp pin Ø 1mm, 0,24 – 1,0 mm ² , AWG 24-18	021.311.1020
Crimp pin Ø 1mm, 0,05 – 0,34 mm ² , AWG 30-22	021.402.1020
Stamped/rolled pin Ø 1mm, 0,03 – 0,08 mm ² , AWG 32-28 HCS™	021.001005.1025 (9000 pcs./reel)
Stamped/rolled pin Ø 1mm, 0,03 – 0,08 mm ² , AWG 32-28 HCS™	021.001005.1025.A2 (300 pcs./reel)
Stamped/rolled pin Ø 1mm, 0,08 – 0,2 mm ² , AWG 28-24 HCS™	021.001006.1025 (9000 pcs./reel)
Stamped/rolled pin Ø 1mm, 0,08 – 0,2 mm ² , AWG 28-24 HCS™	021.001006.1025.A2 (300 pcs./reel)
Stamped/rolled pin Ø 1mm, 0,2 – 0,5 mm ² , AWG 24-20 HCS™	021.001007.1025 (9000 pcs./reel)
Stamped/rolled pin Ø 1mm, 0,2 – 0,5 mm ² , AWG 24-20 HCS™	021.001007.1025.A2 (300 pcs./reel)
Stamped/rolled pin Ø 1mm, 0,75 – 1,0 mm ² , AWG 18 HCS™	021.001008.1025 (9000 pcs./reel)
Stamped/rolled pin Ø 1mm, 0,75 – 1,0 mm ² , AWG 18 HCS™	021.001008.1025.A2 (300 pcs./reel)
Crimp socket Ø 1mm, 0,24 – 1,0 mm ² , AWG 24-18	020.256.1020
Crimp socket Ø 1mm, 0,05 – 0,34 mm ² , AWG 30-22	020.353.1020
Stamped/rolled socket Ø 1mm, 0,03 – 0,08 mm ² , AWG 32-28 HCS™	020.000376.2000 (9000 pcs./reel)
Stamped/rolled socket Ø 1mm, 0,03 – 0,08 mm ² , AWG 32-28 HCS™	020.000376.2000.A2 (300 pcs./reel)
Stamped/rolled socket Ø 1mm, 0,08 – 0,2 mm ² , AWG 28-24 HCS™	020.000377.2000 (9000 pcs./reel)
Stamped/rolled socket Ø 1mm, 0,08 – 0,2 mm ² , AWG 28-24 HCS™	020.000377.2000.A2 (300 pcs./reel)
Stamped/rolled socket Ø 1mm, 0,2 – 0,5 mm ² , AWG 24-20 HCS™	020.000378.2000 (9000 pcs./reel)
Stamped/rolled socket Ø 1mm, 0,2 – 0,5 mm ² , AWG 24-20 HCS™	020.000378.2000.A2 (300 pcs./reel)
Stamped/rolled socket Ø 1mm, 0,75 – 1,0 mm ² , AWG 18 HCS™	020.000379.2000 (9000 pcs./reel)
Stamped/rolled socket Ø 1mm, 0,75 – 1,0 mm ² , AWG 18 HCS™	020.000379.2000.A2 (300 pcs./reel)
Tools <i>please order separately</i>	Part numbers
Crimp tool Ø 1mm	B-150
Positioner Ø 1mm	B-055/A
Tools for stamped/rolled contacts <i>please order separately</i>	Part numbers
Hand crimping tool AWG 32-28	B-287/32-28
Applicator for crimping tool (Schäfer) AWG 32-28	B-288/32-28
Applicator for crimping tool (Kirsten PP3) AWG 32-28	B-286/32-28
Hand crimping tool AWG 28-24	B-287/28-24
Applicator for crimping tool (Schäfer) AWG 28-24	B-288/28-24
Applicator for crimping tool (Kirsten PP3) AWG 28-24	B-286/28-24
Hand crimping tool AWG 24-20	B-287/24-20
Applicator for crimping tool (Schäfer) AWG 24-20	B-288/24-20
Applicator for crimping tool (Kirsten PP3) AWG 24-20	B-286/24-20
Hand crimping tool 0,75 – 1 mm ²	B-287/0,75-1
Applicator for crimping tool (Schäfer) 0,75 – 1 mm ²	B-288/0,75-1
Applicator for crimping tool (Kirsten PP3) 0,75 – 1 mm ²	B-286/0,75-1

Ordering Information

Plug 17way (17 x 1mm)

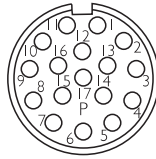

Insulator seen from wired side

17H





Connectors including insulator and cable clamp	Part numbers
Plug with variable shield connection and cable clamp form Ø 5.5 to 12 mm	SPNA17HNNNN169
Plug with flange, variable shield connection and cable clamp from Ø 5.5 to 12 mm	SPNA17HNNNN16914
Plug, plastic shell, variable shield connection, variable cable clamp from Ø 5.5 to 12 mm	SPOC17HNNNN169
Angled plug with variable shield connection and cable clamp from Ø 7.7 to 14.5 mm	SPHA17HNNNN17003
Contacts <i>please order separately</i>	Part numbers
Crimp pin Ø 1mm, 0,24 – 1,0 mm ² , AWG 24-18	021.311.1020
Crimp pin Ø 1mm, 0,05 – 0,34 mm ² , AWG 30-22	021.402.1020
Stamped/rolled pin Ø 1mm, 0,03 – 0,08 mm ² , AWG 32-28 HCS™	021.001005.1025 (9000 pcs./reel)
Stamped/rolled pin Ø 1mm, 0,03 – 0,08 mm ² , AWG 32-28 HCS™	021.001005.1025.A2 (300 pcs./reel)
Stamped/rolled pin Ø 1mm, 0,08 – 0,2 mm ² , AWG 28-24 HCS™	021.001006.1025 (9000 pcs./reel)
Stamped/rolled pin Ø 1mm, 0,08 – 0,2 mm ² , AWG 28-24 HCS™	021.001006.1025.A2 (300 pcs./reel)
Stamped/rolled pin Ø 1mm, 0,2 – 0,5 mm ² , AWG 24-20 HCS™	021.001007.1025 (9000 pcs./reel)
Stamped/rolled pin Ø 1mm, 0,2 – 0,5 mm ² , AWG 24-20 HCS™	021.001007.1025.A2 (300 pcs./reel)
Stamped/rolled pin Ø 1mm, 0,75 – 1,0 mm ² , AWG 18 HCS™	021.001008.1025 (9000 pcs./reel)
Stamped/rolled pin Ø 1mm, 0,75 – 1,0 mm ² , AWG 18 HCS™	021.001008.1025.A2 (300 pcs./reel)
Crimp socket Ø 1mm, 0,24 – 1,0 mm ² , AWG 24-18	020.256.1020
Crimp socket Ø 1mm, 0,05 – 0,34 mm ² , AWG 30-22	020.353.1020
Stamped/rolled socket Ø 1mm, 0,03 – 0,08 mm ² , AWG 32-28 HCS™	020.000376.2000 (9000 pcs./reel)
Stamped/rolled socket Ø 1mm, 0,03 – 0,08 mm ² , AWG 32-28 HCS™	020.000376.2000.A2 (300 pcs./reel)
Stamped/rolled socket Ø 1mm, 0,08 – 0,2 mm ² , AWG 28-24 HCS™	020.000377.2000 (9000 pcs./reel)
Stamped/rolled socket Ø 1mm, 0,08 – 0,2 mm ² , AWG 28-24 HCS™	020.000377.2000.A2 (300 pcs./reel)
Stamped/rolled socket Ø 1mm, 0,2 – 0,5 mm ² , AWG 24-20 HCS™	020.000378.2000 (9000 pcs./reel)
Stamped/rolled socket Ø 1mm, 0,2 – 0,5 mm ² , AWG 24-20 HCS™	020.000378.2000.A2 (300 pcs./reel)
Stamped/rolled socket Ø 1mm, 0,75 – 1,0 mm ² , AWG 18 HCS™	020.000379.2000 (9000 pcs./reel)
Stamped/rolled socket Ø 1mm, 0,75 – 1,0 mm ² , AWG 18 HCS™	020.000379.2000.A2 (300 pcs./reel)
Tools <i>please order separately</i>	Part numbers
Crimp tool Ø 1mm	B-150
Positioner Ø 1mm	B-055/A
Tools for stamped/rolled contacts <i>please order separately</i>	Part numbers
Hand crimping tool AWG 32-28	B-287/32-28
Applicator for crimping tool (Schäfer) AWG 32-28	B-288/32-28
Applicator for crimping tool (Kirsten PP3) AWG 32-28	B-286/32-28
Hand crimping tool AWG 28-24	B-287/28-24
Applicator for crimping tool (Schäfer) AWG 28-24	B-288/28-24
Applicator for crimping tool (Kirsten PP3) AWG 28-24	B-286/28-24
Hand crimping tool AWG 24-20	B-287/24-20
Applicator for crimping tool (Schäfer) AWG 24-20	B-288/24-20
Applicator for crimping tool (Kirsten PP3) AWG 24-20	B-286/24-20
Hand crimping tool 0,75 – 1 mm ²	B-287/0,75-1
Applicator for crimping tool (Schäfer) 0,75 – 1 mm ²	B-288/0,75-1
Applicator for crimping tool (Kirsten PP3) 0,75 – 1 mm ²	B-286/0,75-1

Dimensions are in mm





Mounting styles / dimensions

<p>Drilling drawing for SFFA / SFMB / SEYA</p>	
<p>Drilling drawing for connectors with mounting flange SRNA/SPNA</p>	
<p>Cable Clamp no. 169 for SPOC / SROC / SPNA / SRNA Clamp range: - with reduction sleeve for cable ϕ 5.5-8.5 mm - without reduction sleeve for cable ϕ 8-12 mm</p>	

Accessories

Hand crimping tools	Positioners
 <p>B150</p>	 <p>B055A</p>
 <p>B151</p>	 <p>B201 B257</p>
 <p>B287 with feeder line for stamped/rolled contacts</p>	

Other accessories

		<p>Part number: 031.287.1000 (short version) 031.405.1000 (long version)</p>	
<p>Thread protection cap</p>			
<p><i>Dust shield caps</i></p>			
			
<p>Part number: C/BEL/1</p>	<p>Part number: C/BEL/2</p>	<p>Part number: C/BEL/7</p>	<p>Part number: C/BEL/6</p>
<p>Dust shield cap for receptacles and extensions</p>	<p>Dust shield cap for receptacles and extensions with chain 7.5 mm</p>	<p>Dust shield cap for receptacles and extensions with chain 12 mm</p>	<p>Dust shield cap for plugs with chain 12 mm</p>