

M23 Signal Connectors - Size 1i



Approvals

Tested acc. to DIN EN 61984

Features

- New cable clamp technology, provides a wide cable diameter range (5 -16 mm)
- Optional vibration protection
- Crimp termination for various cross sections

Advantages

- Same outside diameter (26.4 mm) for power and signal connectors allows connector mounting in smaller space, and use of the same external flange
- Power and signal connectors have interchangeable or identical parts for spare reduction and stock pile saving
- New shielding device between braid and metallic connector body, for easier and quicker braid grounding
- Reduced assembly time by minimized number of operations
- New external flange made out of one piece
- Improved mechanical stability
- UL certification available. Contact the factory for relevant part numbers

Markets

Robots, machine tools, production machinery, encoders, servo drives, low voltage applications.

Technical Characteristics

Number of ways:	6way, 7way, 9way, 12way, 16way, 17way
Contact diameter:	6way, 7way, 9way, 12way, 16way, 17way 6way (6 x 2mm) 7way (7 x 2mm) 9way (8 x 1mm + 1 x 2mm); (6 x 1mm + 3 x 2mm); (9 x 1mm) 12way (12 x 1mm) 16way (16 x 1mm) 17way (17 x 1mm)
Nominal current (VDE) / 20°C:	Ø 1 mm 9 A Ø 2 mm 20 A
Contact resistance:	Ø 1 mm <3 mΩ Ø 2 mm <1,3 mΩ
Connector life cycle	500 mating cycles
Rated impulse voltage	Ø 1 mm 2,5 kV Ø 2 mm 2,5 kV
Max. operating voltage (Vrms):	Ø 1 mm 125 Ø 2 mm 125
Operating temperature range:	-40 °C to +125°C
Storage conditions	-40°C to +70°C / humidity 40%
Insulation resistance	Ø 1 mm 10 ¹² Ωcm Ø 2 mm 10 ¹⁶ Ωcm
Insulator material	PA, PBT
Contacts: a) material; b) plating	a) CuZn alloy, tin-bronze b) gold plated and partly gold plated
Shell: a) material, b) plating	a) CuZn alloy; zinc diecast b) nickel plated, chromium-plated
Seals:	FKM
IP code:	IP 67 mated
Contamination level:	3
Over voltage category:	III
Installation altitude:	up to 2000 m

Connector type overview

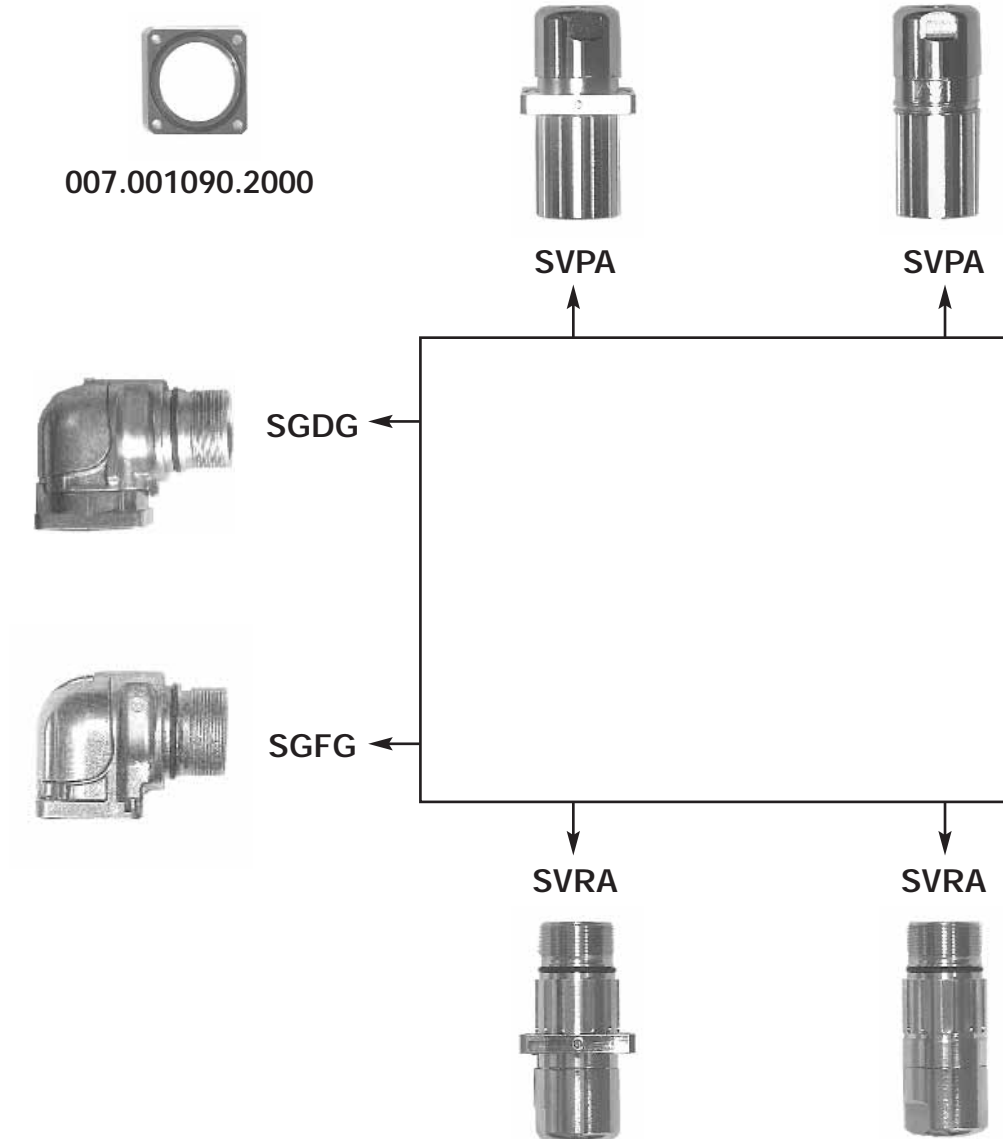

Connector dimensions

Size 1i

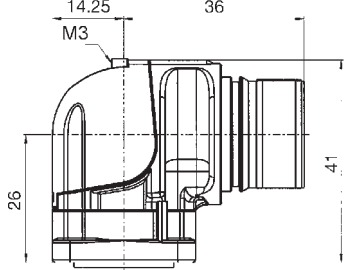
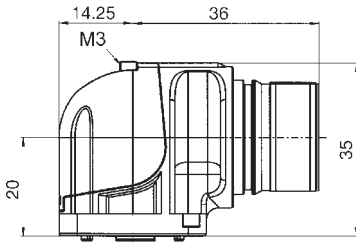
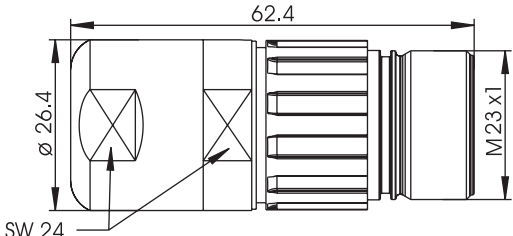
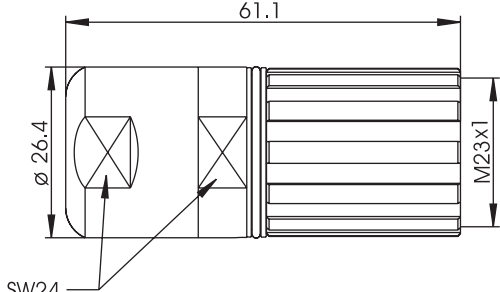
TYPE	DESCRIPTION	DRAWING
SGDG	Rotateable angled receptacle with axial sealing to the device	
SGFG	Fixed angled receptacle with axial sealing to the device	
SVRA	Extension with variable cable clamp and variable shield connection	
SVPA	Plug with variable cable clamp and variable shield connection	

Dimensions are in mm

Ordering information guide

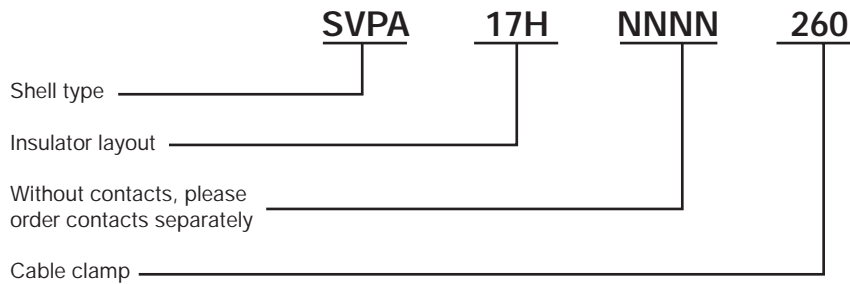

Ordering Information

Receptacle 6way
(6 x 2mm)

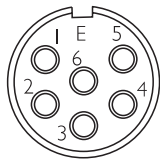

06G

Insulator seen from wired side

Connectors including insulator	Part numbers
Rotateable angled receptacle with axial sealing to the device	SGDG06GNNNN000
Fixed angled receptacle with axial sealing to the device	SGFG06GNNNN000
Contacts <i>please order separately</i>	Part numbers
Crimp pin Ø 2mm, 0,75 – 2,5 mm ² , AWG 18-14	021.310.1020
Crimp socket Ø 2mm, 0,5 – 1,5 mm ² , AWG 20-16	020.315.1020
Tools <i>please order separately</i>	Part numbers
Crimp tool Ø 2 mm	B-151
Positioner Ø 2 mm	B-201

Receptacle 7way
(7 x 2mm)

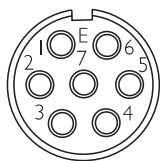

07C

Insulator seen from wired side

Connectors including insulator	Part numbers
Rotateable angled receptacle with axial sealing to the device	SGDG07CNNNN000
Fixed angled receptacle with axial sealing to the device	SGFG07CNNNN000
Contacts <i>please order separately</i>	Part numbers
Crimp pin Ø 2mm, 0,75 – 2,5 mm ² , AWG 18-14	021.310.1020
Crimp socket Ø 2mm, 0,5 – 1,5 mm ² , AWG 20-16	020.315.1020
Tools <i>please order separately</i>	Part numbers
Crimp tool Ø 2 mm	B-151
Positioner Ø 2 mm	B-201

Ordering Information

Receptacle 9way (8 x 1mm + 1 x 2mm)

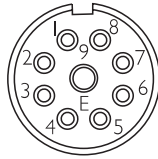

Insulator seen from wired side

09E

Connectors including insulator	Part numbers
Rotateable angled receptacle with axial sealing to the device	SGDG09ENNNN000
Fixed angled receptacle with axial sealing to the device	SGFG09ENNNN000
Contacts <i>please order separately</i>	Part numbers
Crimp pin Ø 1mm, 0,24 – 1,0 mm ² , AWG 24-18	021.311.1020
Crimp pin Ø 2mm, 0,75 – 2,5 mm ² , AWG 18-14	021.310.1020
Crimp socket Ø 1mm, 0,24 – 1,0 mm ² , AWG 24-18	020.256.1020
Crimp socket Ø 2mm, 0,5 – 1,5 mm ² , AWG 20-16	020.315.1020
Tools <i>please order separately</i>	Part numbers
Crimp tool Ø 2mm	B-151
Crimp tool Ø 1mm	B-150
Positioner Ø 2mm	B-201
Positioner Ø 1mm	B-055/A

Receptacle 9way (6 x 1mm + 3 x 2mm)

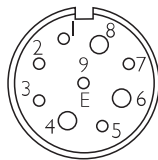

Insulator seen from wired side

09G

Connectors including insulator	Part numbers
Rotateable angled receptacle with axial sealing to the device	SGDG09GNNNN000
Fixed angled receptacle with axial sealing to the device	SGFG09GNNNN000
Contacts <i>please order separately</i>	Part numbers
Crimp pin Ø 1mm, 0,24 – 1,0 mm ² , AWG 24-18	021.311.1020
Crimp pin Ø 2mm, 0,75 – 2,5 mm ² , AWG 18-14	021.310.1020
Crimp socket Ø 1mm, 0,24 – 1,0 mm ² , AWG 24-18	020.256.1020
Crimp socket Ø 2mm, 0,5 – 1,5 mm ² , AWG 20-16	020.315.1020
Tools <i>please order separately</i>	Part numbers
Crimp tool Ø 2mm	B-151
Crimp tool Ø 1mm	B-150
Positioner Ø 2mm	B-201
Positioner Ø 1mm	B-055/A

Ordering Information

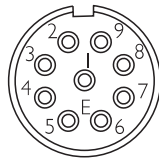
Receptacle 9 way
(9 x 1mm)

Insulator seen from wired side

09J

Connectors including insulator	Part numbers
Rotateable angled receptacle with axial sealing to the device	SGDG09JNNNN000
Fixed angled receptacle with axial sealing to the device	SGFG09JNNNN000
Contacts <i>please order separately</i>	Part numbers
Crimp pin Ø 1mm, 0,24 – 1,0 mm ² , AWG 24-18	021.311.1020
Crimp pin Ø 1mm, 0,05 – 0,34 mm ² , AWG 30 - 22	021.402.1020
Stamped/rolled pin Ø 1mm, 0,03 – 0,08 mm ² , AWG 32-28 HCS™	021.001005.1025 (9000 pcs./reel)
Stamped/rolled pin Ø 1mm, 0,03 – 0,08 mm ² , AWG 32-28 HCS™	021.001005.1025.A2 (300 pcs./reel)
Stamped/rolled pin Ø 1mm, 0,08 – 0,2 mm ² , AWG 28-24 HCS™	021.001006.1025 (9000 pcs./reel)
Stamped/rolled pin Ø 1mm, 0,08 – 0,2 mm ² , AWG 28-24 HCS™	021.001006.1025.A2 (300 pcs./reel)
Stamped/rolled pin Ø 1mm, 0,2 – 0,5 mm ² , AWG 24-20 HCS™	021.001007.1025 (9000 pcs./reel)
Stamped/rolled pin Ø 1mm, 0,2 – 0,5 mm ² , AWG 24-20 HCS™	021.001007.1025.A2 (300 pcs./reel)
Stamped/rolled pin Ø 1mm, 0,75 – 1,0 mm ² , AWG 18 HCS™	021.001008.1025 (9000 pcs./reel)
Stamped/rolled pin Ø 1mm, 0,75 – 1,0 mm ² , AWG 18 HCS™	021.001008.1025.A2 (300 pcs./reel)
Crimp socket Ø 1mm, 0,24 – 1,0 mm ² , AWG 24-18	020.256.1020
Crimp socket Ø 1mm, 0,05 – 0,34 mm ² , AWG 30 - 22	020.353.1020
Stamped/rolled socket Ø 1mm, 0,03 – 0,08 mm ² , AWG 32-28 HCS™	020.000376.2000 (9000 pcs./reel)
Stamped/rolled socket Ø 1mm, 0,03 – 0,08 mm ² , AWG 32-28 HCS™	020.000376.2000.A2 (300 pcs./reel)
Stamped/rolled socket Ø 1mm, 0,08 – 0,2 mm ² , AWG 28-24 HCS™	020.000377.2000 (9000 pcs./reel)
Stamped/rolled socket Ø 1mm, 0,08 – 0,2 mm ² , AWG 28-24 HCS™	020.000377.2000.A2 (300 pcs./reel)
Stamped/rolled socket Ø 1mm, 0,2 – 0,5 mm ² , AWG 24-20 HCS™	020.000378.2000 (9000 pcs./reel)
Stamped/rolled socket Ø 1mm, 0,2 – 0,5 mm ² , AWG 24-20 HCS™	020.000378.2000.A2 (300 pcs./reel)
Stamped/rolled socket Ø 1mm, 0,75 – 1,0 mm ² , AWG 18 HCS™	020.000379.2000 (9000 pcs./reel)
Stamped/rolled socket Ø 1mm, 0,75 – 1,0 mm ² , AWG 18 HCS™	020.000379.2000.A2 (300 pcs./reel)
Tools <i>please order separately</i>	Part numbers
Crimp tool Ø 1mm	B-150
Positioner Ø 1mm	B-055/A
Tools for stamped/rolled contacts <i>please order separately</i>	Part numbers
Hand crimping tool AWG 32-28	B-287/32-28
Applicator for crimping tool (Schäfer) AWG 32-28	B-288/32-28
Applicator for crimping tool (Kirsten PP3) AWG 32-28	B-286/32-28
Hand crimping tool AWG 28-24	B-287/28-24
Applicator for crimping tool (Schäfer) AWG 28-24	B-288/28-24
Applicator for crimping tool (Kirsten PP3) AWG 28-24	B-286/28-24
Hand crimping tool AWG 24-20	B-287/24-20
Applicator for crimping tool (Schäfer) AWG 24-20	B-288/24-20
Applicator for crimping tool (Kirsten PP3) AWG 24-20	B-286/24-20
Hand crimping tool 0,75 – 1 mm ²	B-287/0,75-1
Applicator for crimping tool (Schäfer) 0,75 – 1 mm ²	B-288/0,75-1
Applicator for crimping tool (Kirsten PP3) 0,75 – 1 mm ²	B-286/0,75-1

Ordering Information

Receptacle 12way (12 x 1mm)

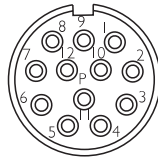

Insulator seen from wired side

12T

Connectors including insulator	Part numbers
Rotateable angled receptacle with axial sealing to the device	SGDG12TNNNN000
Fixed angled receptacle with axial sealing to the device	SGFG12TNNNN000
Contacts <i>please order separately</i>	Part numbers
Crimp pin Ø 1mm, 0,24 – 1,0 mm ² , AWG 24-18	021.311.1020
Crimp pin Ø 1mm, 0,05 – 0,34 mm ² , AWG 30 - 22	021.402.1020
Stamped/rolled pin Ø 1mm, 0,03 – 0,08 mm ² , AWG 32-28 HCS™	021.001005.1025 (9000 pcs./reel)
Stamped/rolled pin Ø 1mm, 0,03 – 0,08 mm ² , AWG 32-28 HCS™	021.001005.1025.A2 (300 pcs./reel)
Stamped/rolled pin Ø 1mm, 0,08 – 0,2 mm ² , AWG 28-24 HCS™	021.001006.1025 (9000 pcs./reel)
Stamped/rolled pin Ø 1mm, 0,08 – 0,2 mm ² , AWG 28-24 HCS™	021.001006.1025.A2 (300 pcs./reel)
Stamped/rolled pin Ø 1mm, 0,2 – 0,5 mm ² , AWG 24-20 HCS™	021.001007.1025 (9000 pcs./reel)
Stamped/rolled pin Ø 1mm, 0,2 – 0,5 mm ² , AWG 24-20 HCS™	021.001007.1025.A2 (300 pcs./reel)
Stamped/rolled pin Ø 1mm, 0,75 – 1,0 mm ² , AWG 18 HCS™	021.001008.1025 (9000 pcs./reel)
Stamped/rolled pin Ø 1mm, 0,75 – 1,0 mm ² , AWG 18 HCS™	021.001008.1025.A2 (300 pcs./reel)
Crimp socket Ø 1mm, 0,24 – 1,0 mm ² , AWG 24-18	020.256.1020
Crimp socket Ø 1mm, 0,05 – 0,34 mm ² , AWG 30 - 22	020.353.1020
Stamped/rolled socket Ø 1mm, 0,03 – 0,08 mm ² , AWG 32-28 HCS™	020.000376.2000 (9000 pcs./reel)
Stamped/rolled socket Ø 1mm, 0,03 – 0,08 mm ² , AWG 32-28 HCS™	020.000376.2000.A2 (300 pcs./reel)
Stamped/rolled socket Ø 1mm, 0,08 – 0,2 mm ² , AWG 28-24 HCS™	020.000377.2000 (9000 pcs./reel)
Stamped/rolled socket Ø 1mm, 0,08 – 0,2 mm ² , AWG 28-24 HCS™	020.000377.2000.A2 (300 pcs./reel)
Stamped/rolled socket Ø 1mm, 0,2 – 0,5 mm ² , AWG 24-20 HCS™	020.000378.2000 (9000 pcs./reel)
Stamped/rolled socket Ø 1mm, 0,2 – 0,5 mm ² , AWG 24-20 HCS™	020.000378.2000.A2 (300 pcs./reel)
Stamped/rolled socket Ø 1mm, 0,75 – 1,0 mm ² , AWG 18 HCS™	020.000379.2000 (9000 pcs./reel)
Stamped/rolled socket Ø 1mm, 0,75 – 1,0 mm ² , AWG 18 HCS™	020.000379.2000.A2 (300 pcs./reel)
Tools <i>please order separately</i>	Part numbers
Crimp tool Ø 1mm	B-150
Positioner Ø 1mm	B-055/A
Tools for stamped/rolled contacts <i>please order separately</i>	Part numbers
Hand crimping tool AWG 32-28	B-287/32-28
Applicator for crimping tool (Schäfer) AWG 32-28	B-288/32-28
Applicator for crimping tool (Kirsten PP3) AWG 32-28	B-286/32-28
Hand crimping tool AWG 28-24	B-287/28-24
Applicator for crimping tool (Schäfer) AWG 28-24	B-288/28-24
Applicator for crimping tool (Kirsten PP3) AWG 28-24	B-286/28-24
Hand crimping tool AWG 24-20	B-287/24-20
Applicator for crimping tool (Schäfer) AWG 24-20	B-288/24-20
Applicator for crimping tool (Kirsten PP3) AWG 24-20	B-286/24-20
Hand crimping tool 0,75 – 1 mm ²	B-287/0,75-1
Applicator for crimping tool (Schäfer) 0,75 – 1 mm ²	B-288/0,75-1
Applicator for crimping tool (Kirsten PP3) 0,75 – 1 mm ²	B-286/0,75-1

Ordering Information

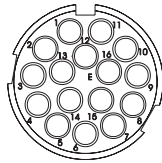
Receptacle 16way
(16 x 1mm)

Insulator seen from wired side

16A

Connectors including insulator	Part numbers
Rotateable angled receptacle with axial sealing to the device	SGDG16ANNNN000
Fixed angled receptacle with axial sealing to the device	SGFG16ANNNN000
Contacts <i>please order separately</i>	Part numbers
Crimp pin Ø 1mm, 0,24 – 1,0 mm ² , AWG 24-18	021.311.1020
Crimp pin Ø 1mm, 0,05 – 0,34 mm ² , AWG 30 - 22	021.402.1020
Stamped/rolled pin Ø 1mm, 0,03 – 0,08 mm ² , AWG 32-28 HCS™	021.001005.1025 (9000 pcs./reel)
Stamped/rolled pin Ø 1mm, 0,03 – 0,08 mm ² , AWG 32-28 HCS™	021.001005.1025.A2 (300 pcs./reel)
Stamped/rolled pin Ø 1mm, 0,08 – 0,2 mm ² , AWG 28-24 HCS™	021.001006.1025 (9000 pcs./reel)
Stamped/rolled pin Ø 1mm, 0,08 – 0,2 mm ² , AWG 28-24 HCS™	021.001006.1025.A2 (300 pcs./reel)
Stamped/rolled pin Ø 1mm, 0,2 – 0,5 mm ² , AWG 24-20 HCS™	021.001007.1025 (9000 pcs./reel)
Stamped/rolled pin Ø 1mm, 0,2 – 0,5 mm ² , AWG 24-20 HCS™	021.001007.1025.A2 (300 pcs./reel)
Stamped/rolled pin Ø 1mm, 0,75 – 1,0 mm ² , AWG 18 HCS™	021.001008.1025 (9000 pcs./reel)
Stamped/rolled pin Ø 1mm, 0,75 – 1,0 mm ² , AWG 18 HCS™	021.001008.1025.A2 (300 pcs./reel)
Crimp socket Ø 1mm, 0,24 – 1,0 mm ² , AWG 24-18	020.256.1020
Crimp socket Ø 1mm, 0,05 – 0,34 mm ² , AWG 30 - 22	020.353.1020
Stamped/rolled socket Ø 1mm, 0,03 – 0,08 mm ² , AWG 32-28 HCS™	020.000376.2000 (9000 pcs./reel)
Stamped/rolled socket Ø 1mm, 0,03 – 0,08 mm ² , AWG 32-28 HCS™	020.000376.2000.A2 (300 pcs./reel)
Stamped/rolled socket Ø 1mm, 0,08 – 0,2 mm ² , AWG 28-24 HCS™	020.000377.2000 (9000 pcs./reel)
Stamped/rolled socket Ø 1mm, 0,08 – 0,2 mm ² , AWG 28-24 HCS™	020.000377.2000.A2 (300 pcs./reel)
Stamped/rolled socket Ø 1mm, 0,2 – 0,5 mm ² , AWG 24-20 HCS™	020.000378.2000 (9000 pcs./reel)
Stamped/rolled socket Ø 1mm, 0,2 – 0,5 mm ² , AWG 24-20 HCS™	020.000378.2000.A2 (300 pcs./reel)
Stamped/rolled socket Ø 1mm, 0,75 – 1,0 mm ² , AWG 18 HCS™	020.000379.2000 (9000 pcs./reel)
Stamped/rolled socket Ø 1mm, 0,75 – 1,0 mm ² , AWG 18 HCS™	020.000379.2000.A2 (300 pcs./reel)
Tools <i>please order separately</i>	Part numbers
Crimp tool Ø 1mm	B-150
Positioner Ø 1mm	B-055/A
Tools for stamped/rolled contacts <i>please order separately</i>	Part numbers
Hand crimping tool AWG 32-28	B-287/32-28
Applicator for crimping tool (Schäfer) AWG 32-28	B-288/32-28
Applicator for crimping tool (Kirsten PP3) AWG 32-28	B-286/32-28
Hand crimping tool AWG 28-24	B-287/28-24
Applicator for crimping tool (Schäfer) AWG 28-24	B-288/28-24
Applicator for crimping tool (Kirsten PP3) AWG 28-24	B-286/28-24
Hand crimping tool AWG 24-20	B-287/24-20
Applicator for crimping tool (Schäfer) AWG 24-20	B-288/24-20
Applicator for crimping tool (Kirsten PP3) AWG 24-20	B-286/24-20
Hand crimping tool 0,75 – 1 mm ²	B-287/0,75-1
Applicator for crimping tool (Schäfer) 0,75 – 1 mm ²	B-288/0,75-1
Applicator for crimping tool (Kirsten PP3) 0,75 – 1 mm ²	B-286/0,75-1

Ordering Information

Receptacle 17way (17 x 1mm)

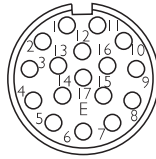

Insulator seen from wired side

17G

Connectors including insulator	Part numbers
Rotateable angled receptacle with axial sealing to the device	SGDG17GNNNN000
Fixed angled receptacle with axial sealing to the device	SGFG17GNNNN000
Contacts <i>please order separately</i>	Part numbers
Crimp pin Ø 1mm, 0,24 – 1,0 mm ² , AWG 24-18	021.311.1020
Crimp pin Ø 1mm, 0,05 – 0,34 mm ² , AWG 30 - 22	021.402.1020
Stamped/rolled pin Ø 1mm, 0,03 – 0,08 mm ² , AWG 32-28 HCS™	021.001005.1025 (9000 pcs./reel)
Stamped/rolled pin Ø 1mm, 0,03 – 0,08 mm ² , AWG 32-28 HCS™	021.001005.1025.A2 (300 pcs./reel)
Stamped/rolled pin Ø 1mm, 0,08 – 0,2 mm ² , AWG 28-24 HCS™	021.001006.1025 (9000 pcs./reel)
Stamped/rolled pin Ø 1mm, 0,08 – 0,2 mm ² , AWG 28-24 HCS™	021.001006.1025.A2 (300 pcs./reel)
Stamped/rolled pin Ø 1mm, 0,2 – 0,5 mm ² , AWG 24-20 HCS™	021.001007.1025 (9000 pcs./reel)
Stamped/rolled pin Ø 1mm, 0,2 – 0,5 mm ² , AWG 24-20 HCS™	021.001007.1025.A2 (300 pcs./reel)
Stamped/rolled pin Ø 1mm, 0,75 – 1,0 mm ² , AWG 18 HCS™	021.001008.1025 (9000 pcs./reel)
Stamped/rolled pin Ø 1mm, 0,75 – 1,0 mm ² , AWG 18 HCS™	021.001008.1025.A2 (300 pcs./reel)
Crimp socket Ø 1mm, 0,24 – 1,0 mm ² , AWG 24-18	020.256.1020
Crimp socket Ø 1mm, 0,05 – 0,34 mm ² , AWG 30 - 22	020.353.1020
Stamped/rolled socket Ø 1mm, 0,03 – 0,08 mm ² , AWG 32-28 HCS™	020.000376.2000 (9000 pcs./reel)
Stamped/rolled socket Ø 1mm, 0,03 – 0,08 mm ² , AWG 32-28 HCS™	020.000376.2000.A2 (300 pcs./reel)
Stamped/rolled socket Ø 1mm, 0,08 – 0,2 mm ² , AWG 28-24 HCS™	020.000377.2000 (9000 pcs./reel)
Stamped/rolled socket Ø 1mm, 0,08 – 0,2 mm ² , AWG 28-24 HCS™	020.000377.2000.A2 (300 pcs./reel)
Stamped/rolled socket Ø 1mm, 0,2 – 0,5 mm ² , AWG 24-20 HCS™	020.000378.2000 (9000 pcs./reel)
Stamped/rolled socket Ø 1mm, 0,2 – 0,5 mm ² , AWG 24-20 HCS™	020.000378.2000.A2 (300 pcs./reel)
Stamped/rolled socket Ø 1mm, 0,75 – 1,0 mm ² , AWG 18 HCS™	020.000379.2000 (9000 pcs./reel)
Stamped/rolled socket Ø 1mm, 0,75 – 1,0 mm ² , AWG 18 HCS™	020.000379.2000.A2 (300 pcs./reel)
Tools <i>please order separately</i>	Part numbers
Crimp tool Ø 1mm	B-150
Positioner Ø 1mm	B-055/A
Tools for stamped/rolled contacts <i>please order separately</i>	Part numbers
Hand crimping tool AWG 32-28	B-287/32-28
Applicator for crimping tool (Schäfer) AWG 32-28	B-288/32-28
Applicator for crimping tool (Kirsten PP3) AWG 32-28	B-286/32-28
Hand crimping tool AWG 28-24	B-287/28-24
Applicator for crimping tool (Schäfer) AWG 28-24	B-288/28-24
Applicator for crimping tool (Kirsten PP3) AWG 28-24	B-286/28-24
Hand crimping tool AWG 24-20	B-287/24-20
Applicator for crimping tool (Schäfer) AWG 24-20	B-288/24-20
Applicator for crimping tool (Kirsten PP3) AWG 24-20	B-286/24-20
Hand crimping tool 0,75 – 1 mm ²	B-287/0,75-1
Applicator for crimping tool (Schäfer) 0,75 – 1 mm ²	B-288/0,75-1
Applicator for crimping tool (Kirsten PP3) 0,75 – 1 mm ²	B-286/0,75-1

Ordering Information

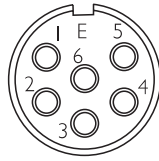
 Extension 6way
 (6 x 2 mm)

Insulator seen from wired side

06G

Connectors including insulator and cable clamp	Part numbers
Extension with variable cable clamp 5 – 9 mm and variable shield connection	SVRA06GNNNNN260
Extension with variable cable clamp 9 – 15 mm and variable shield connection	SVRA06GNNNNN261
Extension with cable clamp 16 mm and variable shield connection	SVRA06GNNNNN262
Contacts <i>please order separately</i>	Part numbers
Crimp pin Ø 2mm, 0,75 – 2,5 mm ² , AWG 18-14	021.310.1020
Crimp socket Ø 2mm, 0,5 – 1,5 mm ² , AWG 20-16	020.315.1020
Tools <i>please order separately</i>	Part numbers
Crimp tool Ø 2mm	B-151
Positioner Ø 2mm	B-201

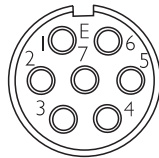
 Extension 7way
 (7 x 2 mm)

Insulator seen from wired side

07C

Connectors including insulator and cable clamp	Part numbers
Extension with variable cable clamp 5 – 9 mm and variable shield connection	SVRA07CNNNNN260
Extension with variable cable clamp 9 – 15 mm and variable shield connection	SVRA07CNNNNN261
Extension with cable clamp 16 mm and variable shield connection	SVRA07CNNNNN262
Contacts <i>please order separately</i>	Part numbers
Crimp pin Ø 2mm, 0,75 – 2,5 mm ² , AWG 18-14	021.310.1020
Crimp socket Ø 2mm, 0,5 – 1,5 mm ² , AWG 20-16	020.315.1020
Tools <i>please order separately</i>	Part numbers
Crimp tool Ø 2mm	B-151
Positioner Ø 2mm	B-201

Ordering Information

Extension 9way (8 x 1mm + 1 x 2mm)

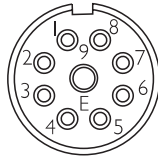

Insulator seen from wired side

09E

Connectors including insulator and cable clamp	Part numbers
Extension with variable cable clamp 5 – 9 mm and variable shield connection	SVRA09ENNNN260
Extension with variable cable clamp 9 – 15 mm and variable shield connection	SVRA09ENNNN261
Extension with cable clamp 16 mm and variable shield connection	SVRA09ENNNN262
Contacts <i>please order separately</i>	Part numbers
Crimp pin Ø 1mm, 0,24 – 1,0 mm ² , AWG 24-18	021.311.1020
Crimp pin Ø 2mm, 0,75 – 2,5 mm ² , AWG 18-14	021.310.1020
Crimp socket Ø 1mm, 0,24 – 1,0 mm ² , AWG 24-18	020.256.1020
Crimp socket Ø 2mm, 0,5 – 1,5 mm ² , AWG 20-16	020.315.1020
Tools <i>please order separately</i>	Part numbers
Crimp tool Ø 2mm	B-151
Crimp tool Ø 1mm	B-150
Positioner Ø 2mm	B-201
Positioner Ø 1mm	B-055/A

Extension 9way (6 x 1mm + 3 x 2mm)

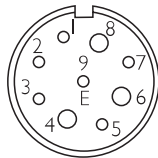

Insulator seen from wired side

09G

Connectors including insulator and cable clamp	Part numbers
Extension with variable cable clamp 5 – 9 mm and variable shield connection	SVRA09GNNNN260
Extension with variable cable clamp 9 – 15 mm and variable shield connection	SVRA09GNNNN261
Extension with cable clamp 16 mm and variable shield connection	SVRA09GNNNN262
Contacts <i>please order separately</i>	Part numbers
Crimp pin Ø 1mm, 0,24 – 1,0 mm ² , AWG 24-18	021.311.1020
Crimp pin Ø 2mm, 0,75 – 2,5 mm ² , AWG 18-14	021.310.1020
Crimp socket Ø 1mm, 0,24 – 1,0 mm ² , AWG 24-18	020.256.1020
Crimp socket Ø 2mm, 0,5 – 1,5 mm ² , AWG 20-16	020.315.1020
Tools <i>please order separately</i>	Part numbers
Crimp tool Ø 2mm	B-151
Crimp tool Ø 1mm	B-150
Positioner Ø 2mm	B-201
Positioner Ø 1mm	B-055/A

Ordering Information

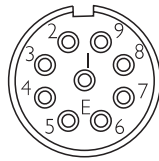
Extension 9way
(9 x 1mm)

Insulator seen from wired side

09J

Connectors including insulator and cable clamp	Part numbers
Extension with variable cable clamp 5 – 9 mm and variable shield connection	SVRA09JNNNN260
Extension with variable cable clamp 9 – 15 mm and variable shield connection	SVRA09JNNNN261
Extension with cable clamp 16 mm and variable shield connection	SVRA09JNNNN262
Contacts <i>please order separately</i>	Part numbers
Crimp pin Ø 1mm, 0,24 – 1,0 mm ² , AWG 24-18	021.311.1020
Crimp pin Ø 1mm, 0,05 – 0,34 mm ² , AWG 30-22	021.402.1020
Stamped/rolled pin Ø 1mm, 0,03 – 0,08 mm ² , AWG 32-28 HCS™	021.001005.1025 (9000 pcs./reel)
Stamped/rolled pin Ø 1mm, 0,03 – 0,08 mm ² , AWG 32-28 HCS™	021.001005.1025.A2 (300 pcs./reel)
Stamped/rolled pin Ø 1mm, 0,08 – 0,2 mm ² , AWG 28-24 HCS™	021.001006.1025 (9000 pcs./reel)
Stamped/rolled pin Ø 1mm, 0,08 – 0,2 mm ² , AWG 28-24 HCS™	021.001006.1025.A2 (300 pcs./reel)
Stamped/rolled pin Ø 1mm, 0,2 – 0,5 mm ² , AWG 24-20 HCS™	021.001007.1025 (9000 pcs./reel)
Stamped/rolled pin Ø 1mm, 0,2 – 0,5 mm ² , AWG 24-20 HCS™	021.001007.1025.A2 (300 pcs./reel)
Stamped/rolled pin Ø 1mm, 0,75 – 1,0 mm ² , AWG 18 HCS™	021.001008.1025 (9000 pcs./reel)
Stamped/rolled pin Ø 1mm, 0,75 – 1,0 mm ² , AWG 18 HCS™	021.001008.1025.A2 (300 pcs./reel)
Crimp socket Ø 1mm, 0,24 – 1,0 mm ² , AWG 24-18	020.256.1020
Crimp socket Ø 1mm, 0,05 – 0,34 mm ² , AWG 30-22	020.353.1020
Stamped/rolled socket Ø 1mm, 0,03 – 0,08 mm ² , AWG 32-28 HCS™	020.000376.2000 (9000 pcs./reel)
Stamped/rolled socket Ø 1mm, 0,03 – 0,08 mm ² , AWG 32-28 HCS™	020.000376.2000.A2 (300 pcs./reel)
Stamped/rolled socket Ø 1mm, 0,08 – 0,2 mm ² , AWG 28-24 HCS™	020.000377.2000 (9000 pcs./reel)
Stamped/rolled socket Ø 1mm, 0,08 – 0,2 mm ² , AWG 28-24 HCS™	020.000377.2000.A2 (300 pcs./reel)
Stamped/rolled socket Ø 1mm, 0,2 – 0,5 mm ² , AWG 24-20 HCS™	020.000378.2000 (9000 pcs./reel)
Stamped/rolled socket Ø 1mm, 0,2 – 0,5 mm ² , AWG 24-20 HCS™	020.000378.2000.A2 (300 pcs./reel)
Stamped/rolled socket Ø 1mm, 0,75 – 1,0 mm ² , AWG 18 HCS™	020.000379.2000 (9000 pcs./reel)
Stamped/rolled socket Ø 1mm, 0,75 – 1,0 mm ² , AWG 18 HCS™	020.000379.2000.A2 (300 pcs./reel)
Tools <i>please order separately</i>	Part numbers
Crimp tool Ø 1mm	B-150
Positioner Ø 1mm	B-055/A
Tools for stamped/rolled contacts <i>please order separately</i>	Part numbers
Hand crimping tool AWG 32-28	B-287/32-28
Applicator for crimping tool (Schäfer) AWG 32-28	B-288/32-28
Applicator for crimping tool (Kirsten PP3) AWG 32-28	B-286/32-28
Hand crimping tool AWG 28-24	B-287/28-24
Applicator for crimping tool (Schäfer) AWG 28-24	B-288/28-24
Applicator for crimping tool (Kirsten PP3) AWG 28-24	B-286/28-24
Hand crimping tool AWG 24-20	B-287/24-20
Applicator for crimping tool (Schäfer) AWG 24-20	B-288/24-20
Applicator for crimping tool (Kirsten PP3) AWG 24-20	B-286/24-20
Hand crimping tool 0,75 – 1 mm ²	B-287/0,75-1
Applicator for crimping tool (Schäfer) 0,75 – 1 mm ²	B-288/0,75-1
Applicator for crimping tool (Kirsten PP3) 0,75 – 1 mm ²	B-286/0,75-1

Ordering Information

Extension 12way (12 x 1mm)

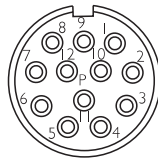

Insulator seen from wired side

12T

Connectors including insulator and cable clamp	Part numbers
Extension with variable cable clamp 5 – 9 mm and variable shield connection	SVRA12TNNNN260
Extension with variable cable clamp 9 – 15 mm and variable shield connection	SVRA12TNNNN261
Extension with cable clamp 16 mm and variable shield connection	SVRA12TNNNN262 SROC12TNNNN169
Contacts <i>please order separately</i>	Part numbers
Crimp pin Ø 1mm, 0,24 – 1,0 mm ² , AWG 24-18	021.311.1020
Crimp pin Ø 1mm, 0,05 – 0,34 mm ² , AWG 30-22	021.402.1020
Stamped/rolled pin Ø 1mm, 0,03 – 0,08 mm ² , AWG 32-28 HCS™	021.001005.1025 (9000 pcs./reel)
Stamped/rolled pin Ø 1mm, 0,03 – 0,08 mm ² , AWG 32-28 HCS™	021.001005.1025.A2 (300 pcs./reel)
Stamped/rolled pin Ø 1mm, 0,08 – 0,2 mm ² , AWG 28-24 HCS™	021.001006.1025 (9000 pcs./reel)
Stamped/rolled pin Ø 1mm, 0,08 – 0,2 mm ² , AWG 28-24 HCS™	021.001006.1025.A2 (300 pcs./reel)
Stamped/rolled pin Ø 1mm, 0,2 – 0,5 mm ² , AWG 24-20 HCS™	021.001007.1025 (9000 pcs./reel)
Stamped/rolled pin Ø 1mm, 0,2 – 0,5 mm ² , AWG 24-20 HCS™	021.001007.1025.A2 (300 pcs./reel)
Stamped/rolled pin Ø 1mm, 0,75 – 1,0 mm ² , AWG 18 HCS™	021.001008.1025 (9000 pcs./reel)
Stamped/rolled pin Ø 1mm, 0,75 – 1,0 mm ² , AWG 18 HCS™	021.001008.1025.A2 (300 pcs./reel)
Crimp socket Ø 1mm, 0,24 – 1,0 mm ² , AWG 24-18	020.256.1020
Crimp socket Ø 1mm, 0,05 – 0,34 mm ² , AWG 30-22	020.353.1020
Stamped/rolled socket Ø 1mm, 0,03 – 0,08 mm ² , AWG 32-28 HCS™	020.000376.2000 (9000 pcs./reel)
Stamped/rolled socket Ø 1mm, 0,03 – 0,08 mm ² , AWG 32-28 HCS™	020.000376.2000.A2 (300 pcs./reel)
Stamped/rolled socket Ø 1mm, 0,08 – 0,2 mm ² , AWG 28-24 HCS™	020.000377.2000 (9000 pcs./reel)
Stamped/rolled socket Ø 1mm, 0,08 – 0,2 mm ² , AWG 28-24 HCS™	020.000377.2000.A2 (300 pcs./reel)
Stamped/rolled socket Ø 1mm, 0,2 – 0,5 mm ² , AWG 24-20 HCS™	020.000378.2000 (9000 pcs./reel)
Stamped/rolled socket Ø 1mm, 0,2 – 0,5 mm ² , AWG 24-20 HCS™	020.000378.2000.A2 (300 pcs./reel)
Stamped/rolled socket Ø 1mm, 0,75 – 1,0 mm ² , AWG 18 HCS™	020.000379.2000 (9000 pcs./reel)
Stamped/rolled socket Ø 1mm, 0,75 – 1,0 mm ² , AWG 18 HCS™	020.000379.2000.A2 (300 pcs./reel)
Tools <i>please order separately</i>	Part numbers
Crimp tool Ø 1mm	B-150
Positioner Ø 1mm	B-055/A
Tools for stamped/rolled contacts <i>please order separately</i>	Part numbers
Hand crimping tool AWG 32-28	B-287/32-28
Applicator for crimping tool (Schäfer) AWG 32-28	B-288/32-28
Applicator for crimping tool (Kirsten PP3) AWG 32-28	B-286/32-28
Hand crimping tool AWG 28-24	B-287/28-24
Applicator for crimping tool (Schäfer) AWG 28-24	B-288/28-24
Applicator for crimping tool (Kirsten PP3) AWG 28-24	B-286/28-24
Hand crimping tool AWG 24-20	B-287/24-20
Applicator for crimping tool (Schäfer) AWG 24-20	B-288/24-20
Applicator for crimping tool (Kirsten PP3) AWG 24-20	B-286/24-20
Hand crimping tool 0,75 – 1 mm ²	B-287/0,75-1
Applicator for crimping tool (Schäfer) 0,75 – 1 mm ²	B-288/0,75-1
Applicator for crimping tool (Kirsten PP3) 0,75 – 1 mm ²	B-286/0,75-1

Ordering Information

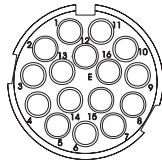
Extension 16way
(16 x 1mm)

Insulator seen from wired side

16A

Connectors including insulator and cable clamp	Part numbers
Extension with variable cable clamp 5 – 9 mm and variable shield connection	SVRA16ANNNN260
Extension with variable cable clamp 9 – 15 mm and variable shield connection	SVRA16ANNNN261
Extension with cable clamp 16 mm and variable shield connection	SVRA16ANNNN262 SROC16ANNNN169
Contacts <i>please order separately</i>	Part numbers
Crimp pin Ø 1mm, 0,24 – 1,0 mm ² , AWG 24-18	021.311.1020
Crimp pin Ø 1mm, 0,05 – 0,34 mm ² , AWG 30-22	021.402.1020
Stamped/rolled pin Ø 1mm, 0,03 – 0,08 mm ² , AWG 32-28 HCS™	021.001005.1025 (9000 pcs./reel)
Stamped/rolled pin Ø 1mm, 0,03 – 0,08 mm ² , AWG 32-28 HCS™	021.001005.1025.A2 (300 pcs./reel)
Stamped/rolled pin Ø 1mm, 0,08 – 0,2 mm ² , AWG 28-24 HCS™	021.001006.1025 (9000 pcs./reel)
Stamped/rolled pin Ø 1mm, 0,08 – 0,2 mm ² , AWG 28-24 HCS™	021.001006.1025.A2 (300 pcs./reel)
Stamped/rolled pin Ø 1mm, 0,2 – 0,5 mm ² , AWG 24-20 HCS™	021.001007.1025 (9000 pcs./reel)
Stamped/rolled pin Ø 1mm, 0,2 – 0,5 mm ² , AWG 24-20 HCS™	021.001007.1025.A2 (300 pcs./reel)
Stamped/rolled pin Ø 1mm, 0,75 – 1,0 mm ² , AWG 18 HCS™	021.001008.1025 (9000 pcs./reel)
Stamped/rolled pin Ø 1mm, 0,75 – 1,0 mm ² , AWG 18 HCS™	021.001008.1025.A2 (300 pcs./reel)
Crimp socket Ø 1mm, 0,24 – 1,0 mm ² , AWG 24-18	020.256.1020
Crimp socket Ø 1mm, 0,05 – 0,34 mm ² , AWG 30-22	020.353.1020
Stamped/rolled socket Ø 1mm, 0,03 – 0,08 mm ² , AWG 32-28 HCS™	020.000376.2000 (9000 pcs./reel)
Stamped/rolled socket Ø 1mm, 0,03 – 0,08 mm ² , AWG 32-28 HCS™	020.000376.2000.A2 (300 pcs./reel)
Stamped/rolled socket Ø 1mm, 0,08 – 0,2 mm ² , AWG 28-24 HCS™	020.000377.2000 (9000 pcs./reel)
Stamped/rolled socket Ø 1mm, 0,08 – 0,2 mm ² , AWG 28-24 HCS™	020.000377.2000.A2 (300 pcs./reel)
Stamped/rolled socket Ø 1mm, 0,2 – 0,5 mm ² , AWG 24-20 HCS™	020.000378.2000 (9000 pcs./reel)
Stamped/rolled socket Ø 1mm, 0,2 – 0,5 mm ² , AWG 24-20 HCS™	020.000378.2000.A2 (300 pcs./reel)
Stamped/rolled socket Ø 1mm, 0,75 – 1,0 mm ² , AWG 18 HCS™	020.000379.2000 (9000 pcs./reel)
Stamped/rolled socket Ø 1mm, 0,75 – 1,0 mm ² , AWG 18 HCS™	020.000379.2000.A2 (300 pcs./reel)
Tools <i>please order separately</i>	Part numbers
Crimp tool Ø 1mm	B-150
Positioner Ø 1mm	B-055/A
Tools for stamped/rolled contacts <i>please order separately</i>	Part numbers
Hand crimping tool AWG 32-28	B-287/32-28
Applicator for crimping tool (Schäfer) AWG 32-28	B-288/32-28
Applicator for crimping tool (Kirsten PP3) AWG 32-28	B-286/32-28
Hand crimping tool AWG 28-24	B-287/28-24
Applicator for crimping tool (Schäfer) AWG 28-24	B-288/28-24
Applicator for crimping tool (Kirsten PP3) AWG 28-24	B-286/28-24
Hand crimping tool AWG 24-20	B-287/24-20
Applicator for crimping tool (Schäfer) AWG 24-20	B-288/24-20
Applicator for crimping tool (Kirsten PP3) AWG 24-20	B-286/24-20
Hand crimping tool 0,75 – 1 mm ²	B-287/0,75-1
Applicator for crimping tool (Schäfer) 0,75 – 1 mm ²	B-288/0,75-1
Applicator for crimping tool (Kirsten PP3) 0,75 – 1 mm ²	B-286/0,75-1

Ordering Information

Extension 17way (17 x 1mm)

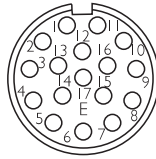

Insulator seen from wired side

17G

Connectors including insulator and cable clamp	Part numbers
Extension with variable cable clamp 5 – 9 mm and variable shield connection	SVRA17GNNNN260
Extension with variable cable clamp 9 – 15 mm and variable shield connection	SVRA17GNNNN261
Extension with cable clamp 16 mm and variable shield connection	SVRA17GNNNN262 SROC17GNNNN169
Contacts <i>please order separately</i>	Part numbers
Crimp pin Ø 1mm, 0,24 – 1,0 mm ² , AWG 24-18	021.311.1020
Crimp pin Ø 1mm, 0,05 – 0,34 mm ² , AWG 30-22	021.402.1020
Stamped/rolled pin Ø 1mm, 0,03 – 0,08 mm ² , AWG 32-28 HCS™	021.001005.1025 (9000 pcs./reel)
Stamped/rolled pin Ø 1mm, 0,03 – 0,08 mm ² , AWG 32-28 HCS™	021.001005.1025.A2 (300 pcs./reel)
Stamped/rolled pin Ø 1mm, 0,08 – 0,2 mm ² , AWG 28-24 HCS™	021.001006.1025 (9000 pcs./reel)
Stamped/rolled pin Ø 1mm, 0,08 – 0,2 mm ² , AWG 28-24 HCS™	021.001006.1025.A2 (300 pcs./reel)
Stamped/rolled pin Ø 1mm, 0,2 – 0,5 mm ² , AWG 24-20 HCS™	021.001007.1025 (9000 pcs./reel)
Stamped/rolled pin Ø 1mm, 0,2 – 0,5 mm ² , AWG 24-20 HCS™	021.001007.1025.A2 (300 pcs./reel)
Stamped/rolled pin Ø 1mm, 0,75 – 1,0 mm ² , AWG 18 HCS™	021.001008.1025 (9000 pcs./reel)
Stamped/rolled pin Ø 1mm, 0,75 – 1,0 mm ² , AWG 18 HCS™	021.001008.1025.A2 (300 pcs./reel)
Crimp socket Ø 1mm, 0,24 – 1,0 mm ² , AWG 24-18	020.256.1020
Crimp socket Ø 1mm, 0,05 – 0,34 mm ² , AWG 30-22	020.353.1020
Stamped/rolled socket Ø 1mm, 0,03 – 0,08 mm ² , AWG 32-28 HCS™	020.000376.2000 (9000 pcs./reel)
Stamped/rolled socket Ø 1mm, 0,03 – 0,08 mm ² , AWG 32-28 HCS™	020.000376.2000.A2 (300 pcs./reel)
Stamped/rolled socket Ø 1mm, 0,08 – 0,2 mm ² , AWG 28-24 HCS™	020.000377.2000 (9000 pcs./reel)
Stamped/rolled socket Ø 1mm, 0,08 – 0,2 mm ² , AWG 28-24 HCS™	020.000377.2000.A2 (300 pcs./reel)
Stamped/rolled socket Ø 1mm, 0,2 – 0,5 mm ² , AWG 24-20 HCS™	020.000378.2000 (9000 pcs./reel)
Stamped/rolled socket Ø 1mm, 0,2 – 0,5 mm ² , AWG 24-20 HCS™	020.000378.2000.A2 (300 pcs./reel)
Stamped/rolled socket Ø 1mm, 0,75 – 1,0 mm ² , AWG 18 HCS™	020.000379.2000 (9000 pcs./reel)
Stamped/rolled socket Ø 1mm, 0,75 – 1,0 mm ² , AWG 18 HCS™	020.000379.2000.A2 (300 pcs./reel)
Tools <i>please order separately</i>	Part numbers
Crimp tool Ø 1mm	B-150
Positioner Ø 1mm	B-055/A
Tools for stamped/rolled contacts <i>please order separately</i>	Part numbers
Hand crimping tool AWG 32-28	B-287/32-28
Applicator for crimping tool (Schäfer) AWG 32-28	B-288/32-28
Applicator for crimping tool (Kirsten PP3) AWG 32-28	B-286/32-28
Hand crimping tool AWG 28-24	B-287/28-24
Applicator for crimping tool (Schäfer) AWG 28-24	B-288/28-24
Applicator for crimping tool (Kirsten PP3) AWG 28-24	B-286/28-24
Hand crimping tool AWG 24-20	B-287/24-20
Applicator for crimping tool (Schäfer) AWG 24-20	B-288/24-20
Applicator for crimping tool (Kirsten PP3) AWG 24-20	B-286/24-20
Hand crimping tool 0,75 – 1 mm ²	B-287/0,75-1
Applicator for crimping tool (Schäfer) 0,75 – 1 mm ²	B-288/0,75-1
Applicator for crimping tool (Kirsten PP3) 0,75 – 1 mm ²	B-286/0,75-1

Ordering Information

Plug 6way
(6 x 2mm)

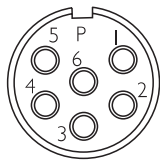

Insulator seen from wired side

06H

Connectors including insulator and cable clamp	Part numbers
Plug with variable cable clamp 5 – 9 mm and variable shield connection	SVPA06HNNNN260
Plug with variable cable clamp 9 – 15 mm and variable shield connection	SVPA06HNNNN261
Plug with cable clamp 16 mm and variable shield connection	SVPA06HNNNN262

Contacts <i>please order separately</i>	Part numbers
Crimp pin Ø 2mm, 0,75 – 2,5 mm ² , AWG 18-14	021.310.1020
Crimp socket Ø 2mm, 0,5 – 1,5 mm ² , AWG 20-16	020.315.1020

Tools <i>please order separately</i>	Part numbers
Crimp tool Ø 2mm	B-151
Positioner Ø 2mm	B-201

Plug 7way
(7 x 2mm)

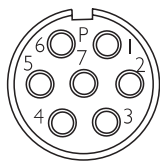

Insulator seen from wired side

07D

Connectors including insulator and cable clamp	Part numbers
Plug with variable cable clamp 5 – 9 mm and variable shield connection	SVPA07DNNNN260
Plug with variable cable clamp 9 – 15 mm and variable shield connection	SVPA07DNNNN261
Plug with cable clamp 16 mm and variable shield connection	SVPA07DNNNN262

Contacts <i>please order separately</i>	Part numbers
Crimp pin Ø 2mm, 0,75 – 2,5 mm ² , AWG 18-14	021.310.1020
Crimp socket Ø 2mm, 0,5 – 1,5 mm ² , AWG 20-16	020.315.1020

Tools <i>please order separately</i>	Part numbers
Crimp tool Ø 2mm	B-151
Positioner Ø 2mm	B-201

Ordering Information

Plug 9way
(8 x 1mm + 1 x 2mm)

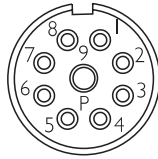

Insulator seen from wired side

09F

Connectors including insulator and cable clamp	Part numbers
Plug with variable cable clamp 5 – 9 mm and variable shield connection	SVPA09FNNNNN260
Plug with variable cable clamp 9 – 15 mm and variable shield connection	SVPA09FNNNNN261
Plug with cable clamp 16 mm and variable shield connection	SVPA09FNNNNN262

Contacts <i>please order separately</i>	Part numbers
Crimp pin Ø 1mm, 0,24 – 1,0 mm ² , AWG 24-18	021.311.1020
Crimp pin Ø 2mm, 0,75 – 2,5 mm ² , AWG 18-14	021.310.1020
Crimp socket Ø 1mm, 0,24 – 1,0 mm ² , AWG 24-18	020.256.1020
Crimp socket Ø 2mm, 0,5 – 1,5 mm ² , AWG 20-16	020.315.1020

Tools <i>please order separately</i>	Part numbers
Crimp tool Ø 2mm	B-151
Crimp tool Ø 1mm	B-150
Positioner Ø 2mm	B-201
Positioner Ø 1mm	B-055/A

Plug 9way
(6 x 1mm + 3 x 2mm)

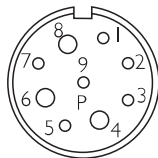

Insulator seen from wired side

09H

Connectors including insulator and cable clamp	Part numbers
Plug with variable cable clamp 5 – 9 mm and variable shield connection	SVPA09HNNNNN260
Plug with variable cable clamp 9 – 15 mm and variable shield connection	SVPA09HNNNNN261
Plug with cable clamp 16 mm and variable shield connection	SVPA09HNNNNN262

Contacts <i>please order separately</i>	Part numbers
Crimp pin Ø 1mm, 0,24 – 1,0 mm ² , AWG 24-18	021.311.1020
Crimp pin Ø 2mm, 0,75 – 2,5 mm ² , AWG 18-14	021.310.1020
Crimp socket Ø 1mm, 0,24 – 1,0 mm ² , AWG 24-18	020.256.1020
Crimp socket Ø 2mm, 0,5 – 1,5 mm ² , AWG 20-16	020.315.1020

Tools <i>please order separately</i>	Part numbers
Crimp tool Ø 2mm	B-151
Crimp tool Ø 1mm	B-150
Positioner Ø 2mm	B-201
Positioner Ø 1mm	B-055/A

Ordering Information

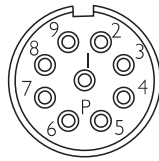
Plug 9way
(9 x 1mm)

Insulator seen from wired side

09K

Connectors including insulator and cable clamp	Part numbers
Plug with variable cable clamp 5 – 9 mm and variable shield connection	SVPA09KNNNN260
Plug with variable cable clamp 9 – 15 mm and variable shield connection	SVPA09KNNNN261
Plug with cable clamp 16 mm and variable shield connection	SVPA09KNNNN262
Contacts <i>please order separately</i>	Part numbers
Crimp pin Ø 1mm, 0,24 – 1,0 mm ² , AWG 24-18	021.311.1020
Crimp pin Ø 1mm, 0,05 – 0,34 mm ² , AWG 30-22	021.402.1020
Stamped/rolled pin Ø 1mm, 0,03 – 0,08 mm ² , AWG 32-28 HCS™	021.001005.1025 (9000 pcs./reel)
Stamped/rolled pin Ø 1mm, 0,03 – 0,08 mm ² , AWG 32-28 HCS™	021.001005.1025.A2 (300 pcs./reel)
Stamped/rolled pin Ø 1mm, 0,08 – 0,2 mm ² , AWG 28-24 HCS™	021.001006.1025 (9000 pcs./reel)
Stamped/rolled pin Ø 1mm, 0,08 – 0,2 mm ² , AWG 28-24 HCS™	021.001006.1025.A2 (300 pcs./reel)
Stamped/rolled pin Ø 1mm, 0,2 – 0,5 mm ² , AWG 24-20 HCS™	021.001007.1025 (9000 pcs./reel)
Stamped/rolled pin Ø 1mm, 0,2 – 0,5 mm ² , AWG 24-20 HCS™	021.001007.1025.A2 (300 pcs./reel)
Stamped/rolled pin Ø 1mm, 0,75 – 1,0 mm ² , AWG 18 HCS™	021.001008.1025 (9000 pcs./reel)
Stamped/rolled pin Ø 1mm, 0,75 – 1,0 mm ² , AWG 18 HCS™	021.001008.1025.A2 (300 pcs./reel)
Crimp socket Ø 1mm, 0,24 – 1,0 mm ² , AWG 24-18	020.256.1020
Crimp socket Ø 1mm, 0,05 – 0,34 mm ² , AWG 30-22	020.353.1020
Stamped/rolled socket Ø 1mm, 0,03 – 0,08 mm ² , AWG 32-28 HCS™	020.000376.2000 (9000 pcs./reel)
Stamped/rolled socket Ø 1mm, 0,03 – 0,08 mm ² , AWG 32-28 HCS™	020.000376.2000.A2 (300 pcs./reel)
Stamped/rolled socket Ø 1mm, 0,08 – 0,2 mm ² , AWG 28-24 HCS™	020.000377.2000 (9000 pcs./reel)
Stamped/rolled socket Ø 1mm, 0,08 – 0,2 mm ² , AWG 28-24 HCS™	020.000377.2000.A2 (300 pcs./reel)
Stamped/rolled socket Ø 1mm, 0,2 – 0,5 mm ² , AWG 24-20 HCS™	020.000378.2000 (9000 pcs./reel)
Stamped/rolled socket Ø 1mm, 0,2 – 0,5 mm ² , AWG 24-20 HCS™	020.000378.2000.A2 (300 pcs./reel)
Stamped/rolled socket Ø 1mm, 0,75 – 1,0 mm ² , AWG 18 HCS™	020.000379.2000 (9000 pcs./reel)
Stamped/rolled socket Ø 1mm, 0,75 – 1,0 mm ² , AWG 18 HCS™	020.000379.2000.A2 (300 pcs./reel)
Tools <i>please order separately</i>	Part numbers
Crimp tool Ø 1mm	B-150
Positioner Ø 1mm	B-055/A
Tools for stamped/rolled contacts <i>please order separately</i>	Part numbers
Hand crimping tool AWG 32-28	B-287/32-28
Applicator for crimping tool (Schäfer) AWG 32-28	B-288/32-28
Applicator for crimping tool (Kirsten PP3) AWG 32-28	B-286/32-28
Hand crimping tool AWG 28-24	B-287/28-24
Applicator for crimping tool (Schäfer) AWG 28-24	B-288/28-24
Applicator for crimping tool (Kirsten PP3) AWG 28-24	B-286/28-24
Hand crimping tool AWG 24-20	B-287/24-20
Applicator for crimping tool (Schäfer) AWG 24-20	B-288/24-20
Applicator for crimping tool (Kirsten PP3) AWG 24-20	B-286/24-20
Hand crimping tool 0,75 – 1 mm ²	B-287/0,75-1
Applicator for crimping tool (Schäfer) 0,75 – 1 mm ²	B-288/0,75-1
Applicator for crimping tool (Kirsten PP3) 0,75 – 1 mm ²	B-286/0,75-1

Ordering Information

Plug 12way (12 x 1mm)

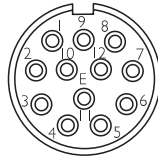

Insulator seen from wired side

12S

Connectors including insulator and cable clamp	Part numbers
Plug with variable cable clamp 5 – 9 mm and variable shield connection	SVPA12SNNNN260
Plug with variable cable clamp 9 – 15 mm and variable shield connection	SVPA12SNNNN261
Plug with cable clamp 16 mm and variable shield connection	SVPA12SNNNN262
Contacts <i>please order separately</i>	Part numbers
Crimp pin Ø 1mm, 0,24 – 1,0 mm ² , AWG 24-18	021.311.1020
Crimp pin Ø 1mm, 0,05 – 0,34 mm ² , AWG 30-22	021.402.1020
Stamped/rolled pin Ø 1mm, 0,03 – 0,08 mm ² , AWG 32-28 HCS™	021.001005.1025 (9000 pcs./reel)
Stamped/rolled pin Ø 1mm, 0,03 – 0,08 mm ² , AWG 32-28 HCS™	021.001005.1025.A2 (300 pcs./reel)
Stamped/rolled pin Ø 1mm, 0,08 – 0,2 mm ² , AWG 28-24 HCS™	021.001006.1025 (9000 pcs./reel)
Stamped/rolled pin Ø 1mm, 0,08 – 0,2 mm ² , AWG 28-24 HCS™	021.001006.1025.A2 (300 pcs./reel)
Stamped/rolled pin Ø 1mm, 0,2 – 0,5 mm ² , AWG 24-20 HCS™	021.001007.1025 (9000 pcs./reel)
Stamped/rolled pin Ø 1mm, 0,2 – 0,5 mm ² , AWG 24-20 HCS™	021.001007.1025.A2 (300 pcs./reel)
Stamped/rolled pin Ø 1mm, 0,75 – 1,0 mm ² , AWG 18 HCS™	021.001008.1025 (9000 pcs./reel)
Stamped/rolled pin Ø 1mm, 0,75 – 1,0 mm ² , AWG 18 HCS™	021.001008.1025.A2 (300 pcs./reel)
Crimp socket Ø 1mm, 0,24 – 1,0 mm ² , AWG 24-18	020.256.1020
Crimp socket Ø 1mm, 0,05 – 0,34 mm ² , AWG 30-22	020.353.1020
Stamped/rolled socket Ø 1mm, 0,03 – 0,08 mm ² , AWG 32-28 HCS™	020.000376.2000 (9000 pcs./reel)
Stamped/rolled socket Ø 1mm, 0,03 – 0,08 mm ² , AWG 32-28 HCS™	020.000376.2000.A2 (300 pcs./reel)
Stamped/rolled socket Ø 1mm, 0,08 – 0,2 mm ² , AWG 28-24 HCS™	020.000377.2000 (9000 pcs./reel)
Stamped/rolled socket Ø 1mm, 0,08 – 0,2 mm ² , AWG 28-24 HCS™	020.000377.2000.A2 (300 pcs./reel)
Stamped/rolled socket Ø 1mm, 0,2 – 0,5 mm ² , AWG 24-20 HCS™	020.000378.2000 (9000 pcs./reel)
Stamped/rolled socket Ø 1mm, 0,2 – 0,5 mm ² , AWG 24-20 HCS™	020.000378.2000.A2 (300 pcs./reel)
Stamped/rolled socket Ø 1mm, 0,75 – 1,0 mm ² , AWG 18 HCS™	020.000379.2000 (9000 pcs./reel)
Stamped/rolled socket Ø 1mm, 0,75 – 1,0 mm ² , AWG 18 HCS™	020.000379.2000.A2 (300 pcs./reel)
Tools <i>please order separately</i>	Part numbers
Crimp tool Ø 1mm	B-150
Positioner Ø 1mm	B-055/A
Tools for stamped/rolled contacts <i>please order separately</i>	Part numbers
Hand crimping tool AWG 32-28	B-287/32-28
Applicator for crimping tool (Schäfer) AWG 32-28	B-288/32-28
Applicator for crimping tool (Kirsten PP3) AWG 32-28	B-286/32-28
Hand crimping tool AWG 28-24	B-287/28-24
Applicator for crimping tool (Schäfer) AWG 28-24	B-288/28-24
Applicator for crimping tool (Kirsten PP3) AWG 28-24	B-286/28-24
Hand crimping tool AWG 24-20	B-287/24-20
Applicator for crimping tool (Schäfer) AWG 24-20	B-288/24-20
Applicator for crimping tool (Kirsten PP3) AWG 24-20	B-286/24-20
Hand crimping tool 0,75 – 1 mm ²	B-287/0,75-1
Applicator for crimping tool (Schäfer) 0,75 – 1 mm ²	B-288/0,75-1
Applicator for crimping tool (Kirsten PP3) 0,75 – 1 mm ²	B-286/0,75-1

Ordering Information

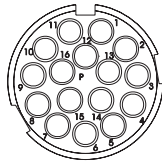
Plug 16way
(16 x 1mm)

Insulator seen from wired side

16B

Connectors including insulator and cable clamp	Part numbers
Plug with variable cable clamp 5 – 9 mm and variable shield connection	SVPA16BNNNN260
Plug with variable cable clamp 9 – 15 mm and variable shield connection	SVPA16BNNNN261
Plug with cable clamp 16 mm and variable shield connection	SVPA16BNNNN262
Contacts <i>please order separately</i>	Part numbers
Crimp pin Ø 1mm, 0,24 – 1,0 mm ² , AWG 24-18	021.311.1020
Crimp pin Ø 1mm, 0,05 – 0,34 mm ² , AWG 30-22	021.402.1020
Stamped/rolled pin Ø 1mm, 0,03 – 0,08 mm ² , AWG 32-28 HCS™	021.001005.1025 (9000 pcs./reel)
Stamped/rolled pin Ø 1mm, 0,03 – 0,08 mm ² , AWG 32-28 HCS™	021.001005.1025.A2 (300 pcs./reel)
Stamped/rolled pin Ø 1mm, 0,08 – 0,2 mm ² , AWG 28-24 HCS™	021.001006.1025 (9000 pcs./reel)
Stamped/rolled pin Ø 1mm, 0,08 – 0,2 mm ² , AWG 28-24 HCS™	021.001006.1025.A2 (300 pcs./reel)
Stamped/rolled pin Ø 1mm, 0,2 – 0,5 mm ² , AWG 24-20 HCS™	021.001007.1025 (9000 pcs./reel)
Stamped/rolled pin Ø 1mm, 0,2 – 0,5 mm ² , AWG 24-20 HCS™	021.001007.1025.A2 (300 pcs./reel)
Stamped/rolled pin Ø 1mm, 0,75 – 1,0 mm ² , AWG 18 HCS™	021.001008.1025 (9000 pcs./reel)
Stamped/rolled pin Ø 1mm, 0,75 – 1,0 mm ² , AWG 18 HCS™	021.001008.1025.A2 (300 pcs./reel)
Crimp socket Ø 1mm, 0,24 – 1,0 mm ² , AWG 24-18	020.256.1020
Crimp socket Ø 1mm, 0,05 – 0,34 mm ² , AWG 30-22	020.353.1020
Stamped/rolled socket Ø 1mm, 0,03 – 0,08 mm ² , AWG 32-28 HCS™	020.000376.2000 (9000 pcs./reel)
Stamped/rolled socket Ø 1mm, 0,03 – 0,08 mm ² , AWG 32-28 HCS™	020.000376.2000.A2 (300 pcs./reel)
Stamped/rolled socket Ø 1mm, 0,08 – 0,2 mm ² , AWG 28-24 HCS™	020.000377.2000 (9000 pcs./reel)
Stamped/rolled socket Ø 1mm, 0,08 – 0,2 mm ² , AWG 28-24 HCS™	020.000377.2000.A2 (300 pcs./reel)
Stamped/rolled socket Ø 1mm, 0,2 – 0,5 mm ² , AWG 24-20 HCS™	020.000378.2000 (9000 pcs./reel)
Stamped/rolled socket Ø 1mm, 0,2 – 0,5 mm ² , AWG 24-20 HCS™	020.000378.2000.A2 (300 pcs./reel)
Stamped/rolled socket Ø 1mm, 0,75 – 1,0 mm ² , AWG 18 HCS™	020.000379.2000 (9000 pcs./reel)
Stamped/rolled socket Ø 1mm, 0,75 – 1,0 mm ² , AWG 18 HCS™	020.000379.2000.A2 (300 pcs./reel)
Tools <i>please order separately</i>	Part numbers
Crimp tool Ø 1mm	B-150
Positioner Ø 1mm	B-055/A
Tools for stamped/rolled contacts <i>please order separately</i>	Part numbers
Hand crimping tool AWG 32-28	B-287/32-28
Applicator for crimping tool (Schäfer) AWG 32-28	B-288/32-28
Applicator for crimping tool (Kirsten PP3) AWG 32-28	B-286/32-28
Hand crimping tool AWG 28-24	B-287/28-24
Applicator for crimping tool (Schäfer) AWG 28-24	B-288/28-24
Applicator for crimping tool (Kirsten PP3) AWG 28-24	B-286/28-24
Hand crimping tool AWG 24-20	B-287/24-20
Applicator for crimping tool (Schäfer) AWG 24-20	B-288/24-20
Applicator for crimping tool (Kirsten PP3) AWG 24-20	B-286/24-20
Hand crimping tool 0,75 – 1 mm ²	B-287/0,75-1
Applicator for crimping tool (Schäfer) 0,75 – 1 mm ²	B-288/0,75-1
Applicator for crimping tool (Kirsten PP3) 0,75 – 1 mm ²	B-286/0,75-1

Ordering Information

Plug 17way (17 x 1mm)

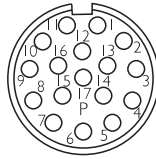

Insulator seen from wired side





17H

Connectors including insulator and cable clamp	Part numbers
Plug with variable cable clamp 5 – 9 mm and variable shield connection	SVPA17HNNNN260
Plug with variable cable clamp 9 – 15 mm and variable shield connection	SVPA17HNNNN261
Plug with cable clamp 16 mm and variable shield connection	SVPA17HNNNN262
Contacts <i>please order separately</i>	Part numbers
Crimp pin Ø 1mm, 0,24 – 1,0 mm ² , AWG 24-18	021.311.1020
Crimp pin Ø 1mm, 0,05 – 0,34 mm ² , AWG 30-22	021.402.1020
Stamped/rolled pin Ø 1mm, 0,03 – 0,08 mm ² , AWG 32-28 HCS™	021.001005.1025 (9000 pcs./reel)
Stamped/rolled pin Ø 1mm, 0,03 – 0,08 mm ² , AWG 32-28 HCS™	021.001005.1025.A2 (300 pcs./reel)
Stamped/rolled pin Ø 1mm, 0,08 – 0,2 mm ² , AWG 28-24 HCS™	021.001006.1025 (9000 pcs./reel)
Stamped/rolled pin Ø 1mm, 0,08 – 0,2 mm ² , AWG 28-24 HCS™	021.001006.1025.A2 (300 pcs./reel)
Stamped/rolled pin Ø 1mm, 0,2 – 0,5 mm ² , AWG 24-20 HCS™	021.001007.1025 (9000 pcs./reel)
Stamped/rolled pin Ø 1mm, 0,2 – 0,5 mm ² , AWG 24-20 HCS™	021.001007.1025.A2 (300 pcs./reel)
Stamped/rolled pin Ø 1mm, 0,75 – 1,0 mm ² , AWG 18 HCS™	021.001008.1025 (9000 pcs./reel)
Stamped/rolled pin Ø 1mm, 0,75 – 1,0 mm ² , AWG 18 HCS™	021.001008.1025.A2 (300 pcs./reel)
Crimp socket Ø 1mm, 0,24 – 1,0 mm ² , AWG 24-18	020.256.1020
Crimp socket Ø 1mm, 0,05 – 0,34 mm ² , AWG 30-22	020.353.1020
Stamped/rolled socket Ø 1mm, 0,03 – 0,08 mm ² , AWG 32-28 HCS™	020.000376.2000 (9000 pcs./reel)
Stamped/rolled socket Ø 1mm, 0,03 – 0,08 mm ² , AWG 32-28 HCS™	020.000376.2000.A2 (300 pcs./reel)
Stamped/rolled socket Ø 1mm, 0,08 – 0,2 mm ² , AWG 28-24 HCS™	020.000377.2000 (9000 pcs./reel)
Stamped/rolled socket Ø 1mm, 0,08 – 0,2 mm ² , AWG 28-24 HCS™	020.000377.2000.A2 (300 pcs./reel)
Stamped/rolled socket Ø 1mm, 0,2 – 0,5 mm ² , AWG 24-20 HCS™	020.000378.2000 (9000 pcs./reel)
Stamped/rolled socket Ø 1mm, 0,2 – 0,5 mm ² , AWG 24-20 HCS™	020.000378.2000.A2 (300 pcs./reel)
Stamped/rolled socket Ø 1mm, 0,75 – 1,0 mm ² , AWG 18 HCS™	020.000379.2000 (9000 pcs./reel)
Stamped/rolled socket Ø 1mm, 0,75 – 1,0 mm ² , AWG 18 HCS™	020.000379.2000.A2 (300 pcs./reel)
Tools <i>please order separately</i>	Part numbers
Crimp tool Ø 1mm	B-150
Positioner Ø 1mm	B-055/A
Tools for stamped/rolled contacts <i>please order separately</i>	Part numbers
Hand crimping tool AWG 32-28	B-287/32-28
Applicator for crimping tool (Schäfer) AWG 32-28	B-288/32-28
Applicator for crimping tool (Kirsten PP3) AWG 32-28	B-286/32-28
Hand crimping tool AWG 28-24	B-287/28-24
Applicator for crimping tool (Schäfer) AWG 28-24	B-288/28-24
Applicator for crimping tool (Kirsten PP3) AWG 28-24	B-286/28-24
Hand crimping tool AWG 24-20	B-287/24-20
Applicator for crimping tool (Schäfer) AWG 24-20	B-288/24-20
Applicator for crimping tool (Kirsten PP3) AWG 24-20	B-286/24-20
Hand crimping tool 0,75 – 1 mm ²	B-287/0,75-1
Applicator for crimping tool (Schäfer) 0,75 – 1 mm ²	B-288/0,75-1
Applicator for crimping tool (Kirsten PP3) 0,75 – 1 mm ²	B-286/0,75-1







Mounting styles / dimensions

<p>Drilling drawing for receptacle SGDG/SGFG</p>	
<p>Variable position SGDG</p>	
<p>Cable clamp for SVPA / SVRA Clamp range: no. 260 for cable \varnothing 5-9 mm no. 261 for cable \varnothing 9-15 mm no. 262 for cable \varnothing 16 mm can be used for shielded and non shielded cables</p>	
<p>Drilling drawing for SVPA / SVRA with flange</p>	

Accessories

Hand crimping tools	Positioners
 <p>B150</p>	 <p>B055A</p>
 <p>B151</p>	 <p>B201 B257</p>
 <p>B287 with feeder line for stamped/rolled contacts</p>	

Other accessories

 <p>Part number: 007.001090.2000</p> <p>Flange mounting by pushing from the connection site and fixing by a grub screw.</p>	 <p>Part number: 031.287.1000 (short version) 031.405.1000 (long version)</p> <p>Thread protection cap</p>
<p><i>Dust shield caps</i></p>	
 <p>Part number: C/BEL/1</p> <p>Dust shield cap for receptacles and extensions</p>	 <p>Part number: C/BEL/2</p> <p>Dust shield cap for receptacles and extensions with chain 7.5 mm</p>
 <p>Part number: C/BEL/7</p> <p>Dust shield cap for receptacles and extensions with chain 12 mm</p>	 <p>Part number: C/BEL/6</p> <p>Dust shield cap for plugs with chain 12 mm</p>